

DK2UDNK
NS
PIERCE

1994-2002 DODGE
2-TON DUMP HOIST

Installation Instructions & Owner's Manual

Please thoroughly read all instructions before beginning installation.

For technical help, call the tech support office at 800-658-6301

Monday-Friday 8:00AM to 5:00PM Central Time

WWW.PIERCEARROWINC.COM

MMXVIII-NS

DK2UDNK Parts Listing

1 PM-319 Hydraulic Pump (power down option will contain PM-3551 Hydraulic Pump)

1 Scissor Assembly (Contains black scissor frame and hydraulic cylinder)

1 Upper Frame (Brown 26.5" x 18")

1 Lower Frame (Brown, 44" x 7.5)

1 Parts box

- Installation/Owner's Manual
- Electrical/Hydraulic/Hardware Bag

Electrical

- 20' #4 Black Wire
- 20' #4 Red Wire
- 6x 5/16" Battery Eye
- 1x 200 Amp Breaker
- 1x 2-Button Pendant Control

Hydraulic

- 1x 5' Hydraulic Hose
- 1x 7' Hydraulic Hose (Standard only with power down kits)
- 1x 90° ¼" Pipe Pump Fitting (Not included in power down kits)
- 2x 90° O-Ring Pump Fitting (Standard only with power down kits)

Hardware

- 2x Hex Screw, 5/8"-11 x 2-1/2" Grade 8
- 2x Flat Washer, 5/8"
- 2x Lock Nut, 5/8"-11 Grade 8
- 18x Hex Screw, 3/8"-16 x 1" Grade 8

- 32x Lock Nut, 3/8"-16 Grade 8
 - 8x Hex Screw, 3/8"-16 x 3"
 - 8x Hex Screw, 3/8"-16 x 1.25"
 - 4x Flat Washer, 3/8"
 - 4x Cotter Pin, 1/8" x 2"
 - 2x 1/8" Cable Clamp
 - 2x Rubber Bumper
 - 1x 3" Hose Clamp
 - 1x Scissor Support Cable
-
- Steel Parts Assortment
 - 2x Frame Hinge (Black, 5" x 4", w/Welded Pipe)
 - 2x Hinge Arm (5.25" x 21.5")
 - 2x Upper Frame Hinge (2.5" x 2")
 - 1x Lower Shaft (15/16" x 8.75")
 - 1x Upper Shaft (15/16" 10-1/8")
 - 2x Guides (Black, Parallelogram, 6" x 1.5")
 - 1x Fuel Filler Bracket (Black, 4" x 12")
 - 1x Pump Bracket (Black, L-Bracket, 7" x 6")



Bed Guides



Clips



Left & Right Frame Hinges



Upper Frame Hinges

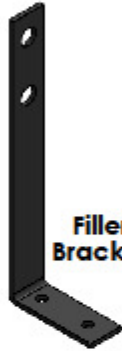

Filler Bracket

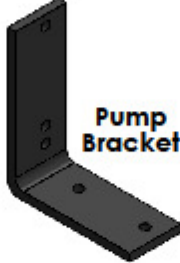

Pump Bracket

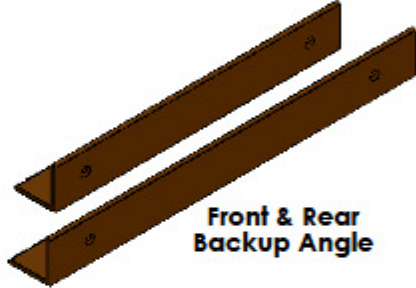

Front & Rear Backup Angle



Lower Shaft



Upper Shaft

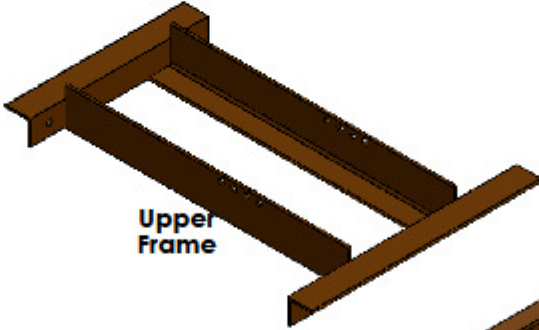

Upper Frame



Left & Right Bed Hinges

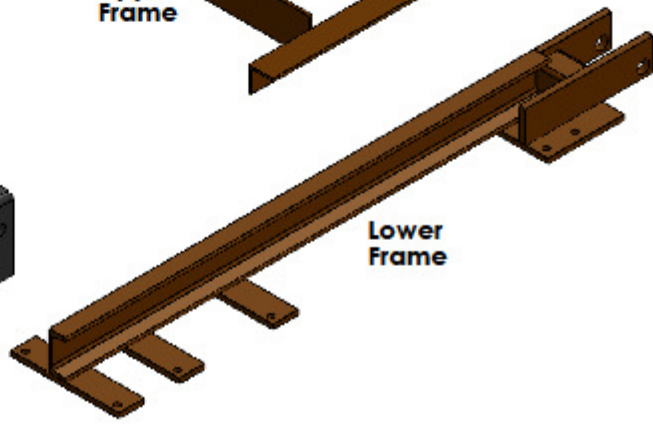

Lower Frame

Important Safety Rules

- Follow all safety rules provided with the power tools used to install your kit.
- Use correctly sized lifting equipment to raise the bed of your truck.
- Always have a backup device in place when working under the bed on your truck. This is in addition to the primary hoist or prop mechanism.
- Wear safety glasses.
- Use UL rated grounded electrical cords and tools.
- Your gas tank is located very close to the scissors and other kit components. Cover with a fireproof tarp and do not allow any sparks in this area. Clean any spills with water.
- Check bed clearance after the hinges are installed to ensure that the bed will not hit the cab during operation.
- Always level the load in your bed.
- Be sure no one is close enough to be injured when you dump the load from your bed.
- Do not exceed the cargo capacity as listed by the truck manufacturer. The kit will lift a level, evenly distributed load of 4000 lbs., including the weight of the bed.
- Dump the load in your truck when your truck is level.
- Grease pins and all moving components monthly.
- Tow trailers only with an appropriated classified receiver hitch. Do not use the bumper for any towing.

Tools and Equipment

Hacksaw or reciprocating saw

Welder or weld shop availability

Correctly rated hoist or lifting device

Cutting torch

Portable electric drill and various sized drill bits

Various Sockets, wrenches, and a slotted screwdriver

Tape measure

C Clamps and vise grips

Safety glasses

Welders mask/helmet

1 gallon of automatic transmission fluid

INSTALLATION OVERVIEW

Read all safety rules. Check the parts list. Disconnect the battery. Remove your bumper. Remove the gas filler from the bed. Disconnect or remove wiring between the frame and the bed. Remove or shorten any spare tire lowering device that would interfere with bed rotation. Remove the bolts holding the bed to the frame. It is not necessary to completely remove your bed. It must be raised high enough in the rear to install the hinges safely. Install the hinges per the directions provided later in this manual. Install the upper frame between the two bed cross members located directly above the main frame. The main frame cross member is located near the front spring hangers for the rear suspension. The left to right position for the upper frame should be as close to the truck centerline as possible, but offset enough that the scissors assembly will clear the gas tank by $\frac{1}{2}$ " or more. See the directions provided later. The scissors will extend forward of the differential assembly. Move any brake lines from the top of the differential to a point lower than the top surface of the differential. This will prevent any accidental damage to your brake system. Always check clearance of brake lines and electrical components to prevent any accidental damage. The position of the scissor assembly will be adjusted up and down by either moving the scissor assembly fore or aft. When the bed is down, the scissor assembly is about level. We provide a cable to support the back end of the scissor to prevent excess movement up/down when your truck hits bumps.

REAR HINGES:

Remove the gas filler assembly from the bed. Mark the original position of the bed on the frame. If equipped, remove the spare tire lowering mechanism from the bumper. Remove the rear bumper. Disconnect the wiring to the bed. Remove the bed to frame bolts. Raise the rear of the bed 7 or 8 inches above the frame. Cut a notch from the top of the frame, 5/8" down and 2" front to back from the rear edge of the frame on both sides. Using the original bed to frame bolts, attach the hinge arms to the bed. The vertical part of the hinge arm will be outside the frame and parallel. Lower the bed into its original location. Keep the bed centered and straight with the truck frame. The hinges will attach to the inside of the frame with the welded pipe aligned with the pivot hole on the hinge arms. You will need to cut the frame where the welded pipe projects toward the pivot hole. Note* For boxed frames, you will need to weld a 3/16" thick plate, about 7"-8" long on the outside of the frame for support. Place a washer between the welded pipe and the hinge arm to space the arm far enough from the bolt head. Insert the 5/8" pivot bolt through the hinge arm pivot hole and the welded pipe on the hinge. Install the 5/8" locknut until there is no play, but the bolt can still rotate. Mark the frame for "hinge to frame" bolt holes. Drill the frame for (4) 3/8" x 1" bolts at each hinge. Install the bolts with the bolt heads on the outside of the frame with the locknuts on the hinge side. The bed will now pivot. Check bed-cab clearance first to ensure the bed will not hit the cab during lift. If the hinge arms are straight and there is no binding by a chain lift or cherry picker, then the hinge arms should be welded to the bed frame. This will enhance the hinge arm to bed connection. All pivot points should be heavily greased at final assembly. Reconnect the wiring.

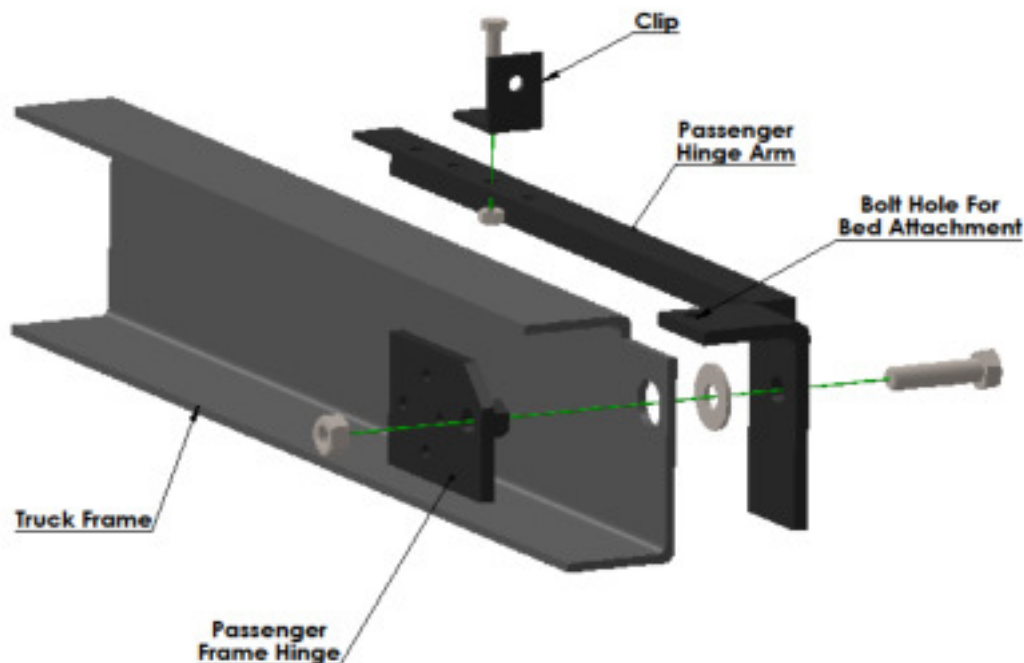

LOWER FRAME:

The lower frame will need to be cut to the appropriate length before installing. The lower frame has three mounting tabs for attaching to the front cross member. You will only use one, depending on which truck the kit is being installed on.

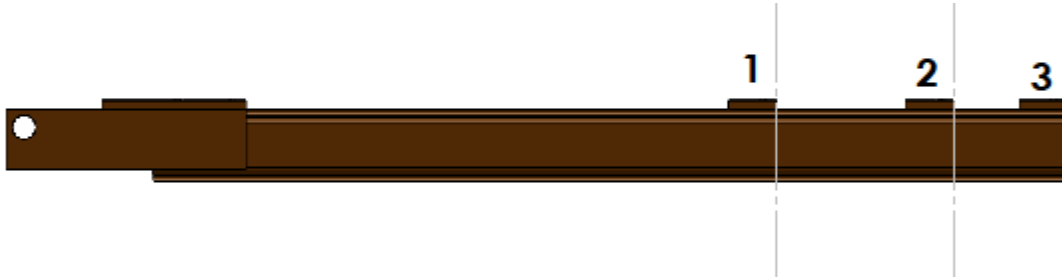

- *For extended cab, long bed trucks, you will not alter the lower frame.
- *For standard cab, long beds, you will cut the lower frame at mounting tab 2.
- *For all short bed trucks, you will cut the lower frame at mounting tab 1.

The lower frame/upper frame/scissor assembly will install 1.25" off the center line of the truck, towards the passenger side. The lower frame will attach to the front cross member and the main frame cross member. Attach the large section of the lower frame to the bottom side of the main frame cross member using four (4) 3/8" x 1.25" bolts and locknuts. The channel with the front cross member mounting tab will extend towards the cab and will be attached to the bottom lip of the front cross member under, or just behind, the back of the cab using the pre-existing holes in the cross member.

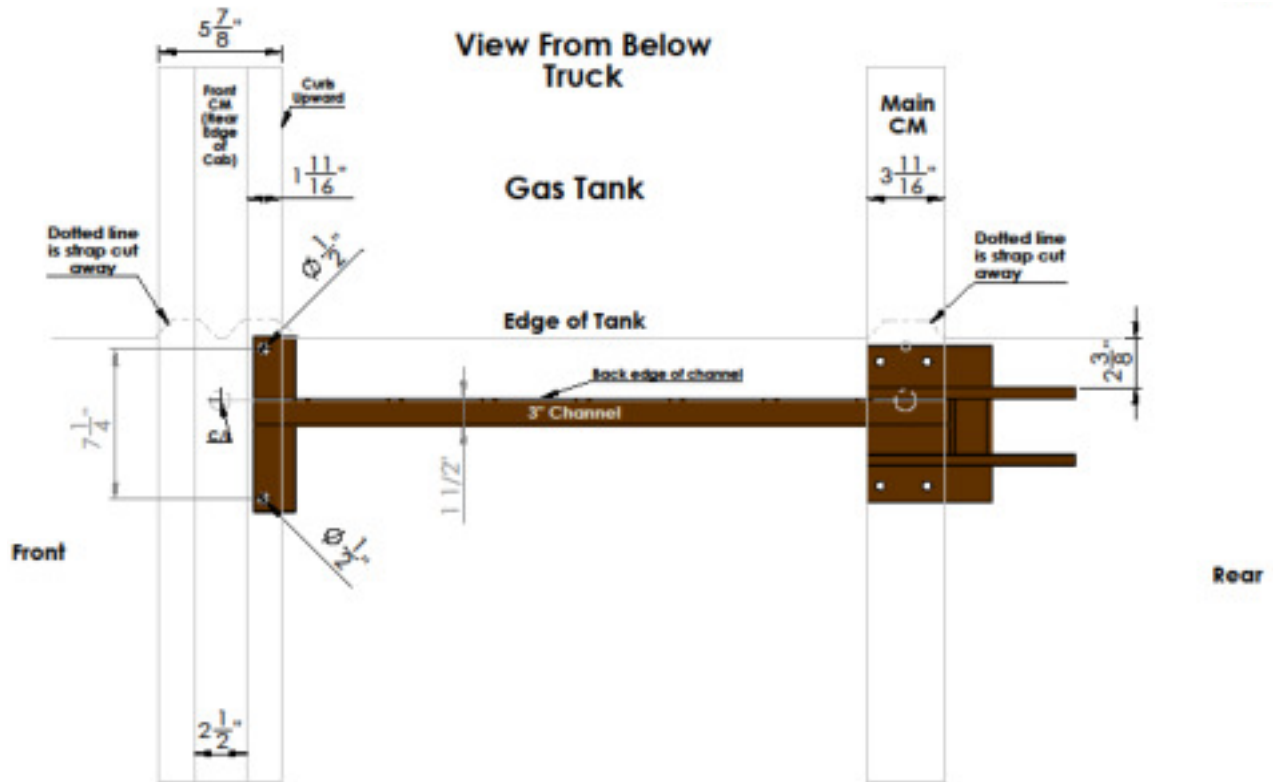

Note: The truck center line is found on Main CM in center of extruded 1" hole, Front CM in center of extruded 3/4" hole.

Install Scissors 1 1/4" off center line of truck away from gas tank. The scissor assembly will be 1 1/4" off CL toward right side of vehicle. The edge of the lower frame plate will be about 1/2" from gas tank.

The back edge of the channel will pass 1/8" to the left of the truck center line. (Between truck center line and gas tank) This applies to both cross members. (Main and Front)

SCISSOR ASSEMBLY A:

Attach the bottom section of the scissor assembly to the lower frame using the 15/16" x 8.75" pin. Allow the assembly to rest in a location that will not be in the way and will not cause any damage where it rests.

UPPER FRAME A:

Loosely attach both hinge brackets to the center two slots on the outside of the upper frame. These may be moved later during the scissor assembly installation to the upper frame. Clamp the upper frame to the bed cross members above the main frame cross member with the longer angle piece towards the rear of the truck and the shorter angle piece towards the cab. Make sure the upper frame is in line with the lower frame and scissor assembly.

SCISSOR ASSEMBLY B:

With the scissors assembly closed, rotate it up and down to check for clearance. The scissor assembly must clear the fuel tank and exhaust system. Remove the plastic plug from the hydraulic cylinder port and open the scissor assembly. Attach the top portion of the scissor assembly to the upper frame hinge tabs and secure with the 15/16" x 10-1/8" pin.

Side
View
Sketch

For 2pc driveshaft vehicles
slide front tab of lower frame
over the bearing studs.
Use 2 extra nuts to secure

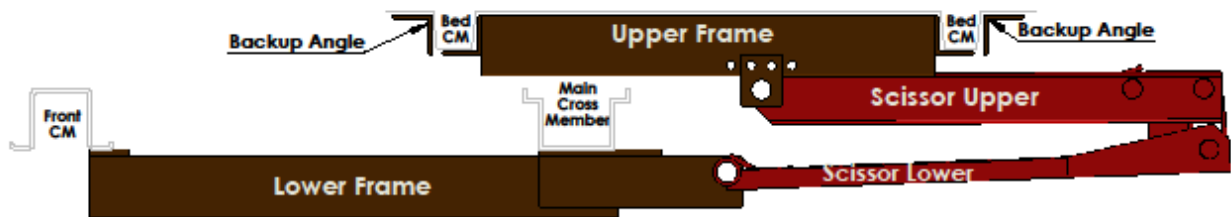

UPPER FRAME B:

With the scissor assembly now attached to the upper frame, mark and drill four 3/8" holes through the upper frame angles into each bed cross member. Secure with 3/8" x 3" bolts. Use the 2" x 2" angle supports to strengthen the upper frame assembly and to prevent crushing the bed cross members. Before powering the bed with hydraulics, raise and lower the bed manually to check for clearance of all parts, and for clearance of the bed and the cab.

RUBBER BUMPER PADS:

The bed should contact these for a quieter operation. Clean off the desired location on the truck or bed frame, near the front of the bed. Remove the adhesive back, and attach the rubber bumper pads.

FUEL FILLER:

The curve of the bed will not allow you to use the OE fuel door to fill your tank. On most trucks, the fuel filler can be cut, shortened and left in place at the front of the bed. Simple, but requires raising the bed a short distance to add fuel. The alternative is to install the filler in the wheel well, as high as possible and clear of the wheel. On most trucks, you can loosen the rubber hose at the tank inlet and rotate the filler into the wheel well. Use the filler bracket to secure the filler tube. On some trucks, this would require you to extend the fuel filler pipe to extend the filler neck to the wheel well. This piece is not provided. If necessary, cut the rubber hose between the fuel tank and the filler so there is enough hose at the tank end for the short end of the extension to enter the hose and clamp with hose clamps. Attach the filler and remaining hose to the long end of the rear wheel well. You must shorten the hose for an exact fit. The filler should be in the upper forward part of the wheel well opening, at an angle to meet a fuel pump nozzle from a fuel pump. The filler must be located so the tire will not touch it at any point. The vent hose must also be extended from the tank to the filler. The third small vent hose can be relocated to the back of the cab where it will not interfere with movement of the bed when dumping.



SUPPORT CABLE:

There is some slack in the scissor assembly when installed. The provided cable can go under the scissors, attaching to both left and right main longitudinal frame

members. Alternatively, a ¼" x 2" flat bar (not included) can be welded to both left and right frame members toward the end of the scissors furthest from the lower frame. A covering of rubber or hose will prevent rattles. This supports the weight of the scissors and unloads the hinge pins. This will also help to keep the scissor assembly from hitting the rear differential.

PUMP:

It is recommended that the pump mount to the outside of the right frame, just forward of the rear spring hanger (This is only recommended, not required. The pump can mount to any "safe" location) using the 8" x 7" L-bracket. The pump should be mounted level, with the vent/filler up, using (2) 3/8"-16 x 1" screws.

You may have to remove the magnetic coil in order to attach the adapter fitting to the pump body. Install the pump fitting and attach the hydraulic hose. Attach the opposite end of the hydraulic hose to the base end of the hydraulic cylinder.

On power down kits, the pump will have (2) ports. The port marked C1 is the high-pressure port. The port marked C2 is the low pressure (return) port. If the pump ports are not labelled, the port on the left-hand side (with the motor pointing towards you, and the reservoir pointing away from you) is the high-pressure port, and the port on the right side is the low-pressure (return) port

The pump's reservoir is supplied with a temporary plastic plug in the fill opening. Fill with up to 1.5 gallons of automatic transmission fluid (Actual amount will vary by pump supplied). After filling the reservoir, install the vented plastic plug into the fill opening. The vented plug is packed in the pump box.

Note* Some pumps interfere with the vertical frame when the pump bracket is bolted to the frame. A spacer may be required to space the pump bracket out from the frame for clearance. It generally will not be needed.

GUIDES:

The guides are the 2 parallelogram shaped pieces that attach to the bed and provide alignment of the bed to the truck, side to side. They attach to the front of the bed and contact the frame, either inside or outside. They also prevent any side to side movement when the bed is down. The bottom of the guides are pointed, so be sure that they do not contact anything other than the edge of the left and right frames.

WIRING:

Wired pendant control:

The power wire (green) on the pendant control will connect to the large power terminal on the solenoid. The “start” wire (black) will connect to the small terminal on the solenoid. The “down” wire (white) will connect to the small terminal on the magnetic coil on the C1 port.

On power down pumps, the “up” wire (red) will connect to the magnetic coil on the C2 port.

*To install a wireless remote, refer to the manufacturer’s installation instructions.

Optional In-Cab Toggle Switch Wiring:

Mount the switch in the dash, or somewhere convenient from the driver’s seat. The switch will mount in a ½” hole. Orient the switch so it moves up and down, vertically. Using the 18/3 ribbon wire, connect the brown wire to the center terminal on your toggle switch. The yellow wire will mount to the top terminal, and the green wire will connect to the bottom terminal.

Positive:

Mount the circuit breaker as close as possible to the battery. Cut the #4 gauge red wire so there is enough cable to reach from the battery’s positive terminal to the circuit breaker with a little slack. Connect the short cable to the positive terminal and the circuit breaker terminal marked “BAT LINE”. Using the remainder of the red wire, connect from the circuit breaker terminal marked “AUX LOAD” to the large terminal on the pump solenoid. Be sure that the red wire does not rub on anything that has a sharp edge, generates heat, or has moving parts.

Negative:

Connect the #4 gauge black wire to the mounting bolt on the side of the pump labelled “GND”. Route the black wire back to the battery. Connect the black wire directly to the negative terminal of the battery. The ground wire MUST be attached as described to the pump and to the battery. Do NOT cut the black wire short and ground to the frame.

NOTE* Be sure not to connect any wire to the solenoid terminal that has a large copper buss bar connecting to the single pump motor terminal. Do not allow any wiring to touch the buss bar, or it’s connections. It is NOT a ground, it is the final connection to the motor.

BUCHER PUMP to BREAKER

PM319 Bucher Pump

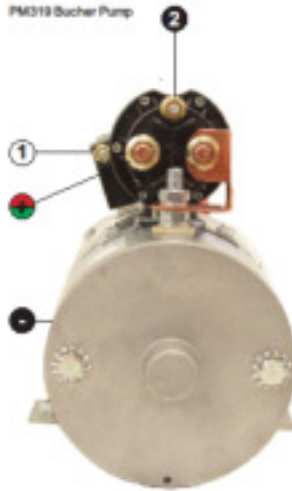

REMOTE CONNECTIONS

Pierce wired or wireless remotes including the P040 and CP271 connect to a PM319. Wired remotes will have three wires whereas the wireless connections will have four.

70631 Breaker

To protect your pump, please use a safety cutoff switch or ampere breaker.



- 2 UP (Black)
- 1 DOWN (White)
- POSITIVE (Red #4 Cable and Green)
- NEGATIVE (Black #4 Cable)

PIERCE

PierceArmed, Inc. • www.piercearmed.com • 1-800-635-6301
549 U.S. HWY 207 S. • Houston, Texas 77060

CATEGORY PUMP

PART NO. PM319

PRODUCT DESCRIPTION

Bucher Pump to Breaker & Remote

WIRING DESCRIPTION

This chart depicts wiring from a Bucher PM319 pump to the Pierce breaker.

NOTE: Place breaker as close to battery as install allows. Use #4 gauge cable for all connections. Use a 5/16-18" x 3/4" bolt for the ground connection. Wiring not included.

WIRING CHART

Connect the wires to the corresponding signs.

- POSITIVE (Red #4 Cable and Green)
- NEGATIVE (Black #4 Cable)
- 1 DOWN (White)
- 2 UP (Black)

BUCHER PUMP

Pm319 Bucher Pump to PS525 Toggle Switch

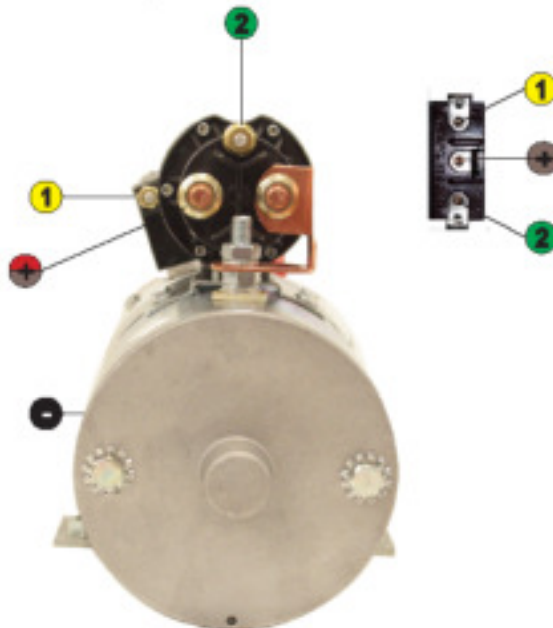

PIERCE

PierceArmed, Inc. • www.piercearmed.com • 1-800-635-6301
549 U.S. HWY 207 S. • Houston, Texas 77060

CATEGORY PUMP

PART NO. Pm319, PM3196P

PRODUCT DESCRIPTION

Bucher Pump to Toggle Switch

WIRING DESCRIPTION

This chart depicts wiring from a Bucher PM319 pump to the Pierce PS525 Toggle Switch.

NOTE: Place breaker as close to battery as install allows. Use #4 gauge cable for all connections. Use a 5/16-18" x 3/4" bolt for the ground connection. Wiring not included.

WIRING CHART

Connect the wires to the corresponding signs.

- POSITIVE (Red #4 Cable and Brown)
- NEGATIVE (Black #4 Cable)
- 1 DOWN (Yellow)
- 2 UP (Green)

BUCHER PUMP

PM119 Bucher Pump

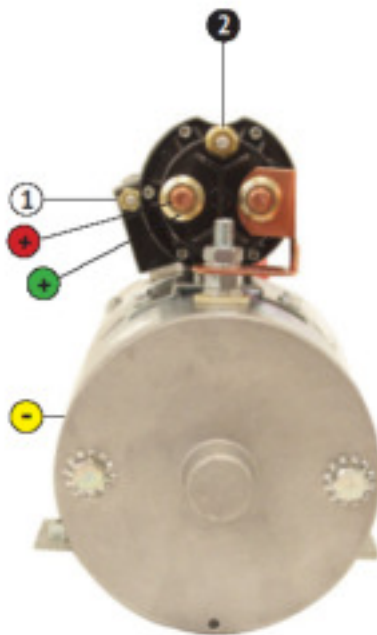

PIERCE

Pierce-Arvin Inc. • www.piercearvin.com • 1-800-438-4381
349 U.S. HWY 287 E. • Houston, Texas 76060

CATEGORY PUMP

PART NO. PM119

PRODUCT DESCRIPTION

Bucher Pump

WIRING DESCRIPTION

This chart depicts wiring from a Bucher PM119 pump to the Pierce CP271MTE.

NOTE: Place breaker as close to battery as install allows. Use #4 gauge cable for all connections. Use a 5/16-18" x 5/4" bolt for the ground connection. Wiring not included.

WIRING CHART

Connect the wires to the corresponding signs.

- + POSITIVE (red to the remote)
- + POSITIVE (green to main power)
- NEGATIVE (yellow to the main ground)
- 1 DOWN (white to the remote)
- 2 UP (black to the remote)

BUCHER PUMP with TWO-WAY VALVE

PM-3551 Bucher Pump with CP077K wired control

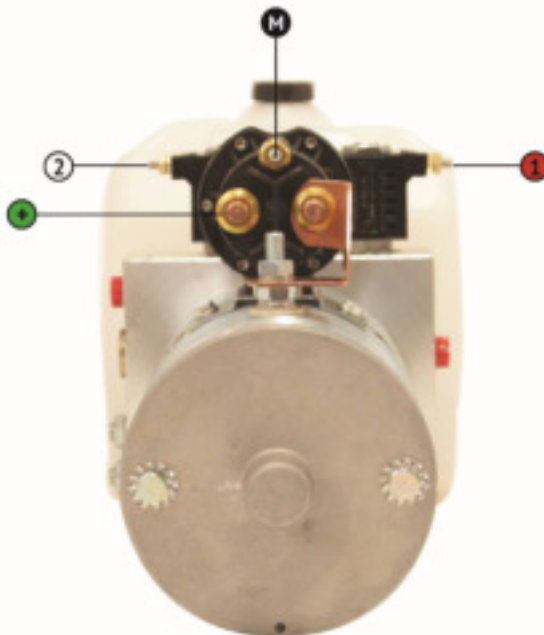

PIERCE

Pierce-Arvin Inc. • www.piercearvin.com • 1-800-438-4381
349 U.S. HWY 287 E. • Houston, Texas 76060

CATEGORY PUMP

PART NO. PM-3551

PRODUCT DESCRIPTION

Bucher Pump with Two-way Valve

WIRING DESCRIPTION

This chart depicts wiring of a Bucher PM-3551 pump.

NOTE: Use #16 or #18 gauge wires for all connections. Use a 5/16-18" x 1.0" bolt for the ground connection. Wiring not included.

WIRING CHART

Connect the wires to the corresponding signs.

- + 12V (green)
- 1 RIGHT COIL (red)
- 2 LEFT COIL (white)
- M MASTER (black)
Compatible with CP077K, 88901155

REAR BUMPER:

The rear bumper is only decorative and provides no function when the hoist kit is installed. Trailers should NOT be towed by the bumper. If there is no receiver hitch, the bumper brackets should be welded to the hinge arms so the bumper will rotate with the bed. The warning label provided with the kit should be applied to the bumper where it is clear and visible.

TOWING:

Receiver hitches should be removed before installing your hoist kit. Upon completion, raise the bed to the highest point, place your receiver hitch near the frame where it is clear of the bed and bumper. You will need to cut and modify the receiver hitch to fit in this new, closer to the front, location. The receiver should be reinforced and welded in place. Note that any modification to the receiver hitch MUST result in a unit that is as strong as in its original configuration. A longer ball mount must be purchased or fabricated from a 2" x 2" flat bar. Check for clearance; This way the bed cannot be inadvertently raised and damaged by the ball mount.

Alternate options:

- Leave receiver hitch in the original location. Remove the OE bumper.
- Leave receiver hitch in the original location. Remove the OE bumper. Fabricate a 1/3 length bumper for the left and right, attach to the hinge arms. The center 1/3 is open to clear the receiver hitch.
- Leave the receiver hitch in the original location. Remove the OE bumper. Install a 2" x 4" rectangular tube just above the receiver hitch and weld it to the frame. It will be a stationary bumper. The 2" dimension is up/down, the 4" dimension is left/right. This choice results in the strongest bumper system and does not interfere with any towing function.

MAINTENANCE:

- Grease all pins, scissor assembly and hinges monthly.
- Fluid should be changed yearly. Once the reservoir is drained, remove the reservoir. Using a mild solvent, clean the screen filter on the suction tube. While the reservoir is off, clean out any debris. Re-install the reservoir, making sure to lubricate the sealing o-ring with hydraulic oil before seating to assist in re-installation. Tighten all screws/ clamps.

- Check wiring, all connections, terminals and battery yearly. Corrosion will cause voltage drops. When corrosion is found, remove any corroded wire and replace any terminals when necessary. If any wire is found frayed or cut, it must be replaced.

TROUBLESHOOTING:

- Bed will not lift:
 - First, check your voltage at the pump. Make sure that there is 12V at the solenoid terminal. Operate the pump and check the voltage again. Power should stay near 12V, but should not drop below 12V. If this is not achieved, check all wiring and all connections.
 - On Power down pumps, make sure that the pump is plumbed properly. The PM-3551 pump has two hydraulic ports. The port labelled C1 should be plumbed to the base end of the cylinder. The port labelled C2 should be plumbed to the rod end of the cylinder.
- Pump is slow
 - First, check your voltage at the pump. Make sure that there is 12V at the solenoid terminal. Operate the pump and check the voltage again. Power should stay near 12V, but should not drop below 12V. If this is not achieved, check all wiring and all connections.
 - Check suction tube filter for blockage (refer to maintenance).
- Leaks
 - Upon installation, there may be a bit of fluid seeping from the cylinder vent. This is not a leak, but merely residual fluid from pressure testing the cylinder.
 - If fluid is leaking from any fittings or hose, simply tighten the fitting. DO NOT use pipe thread sealant tape on any fittings. Only use pipe thread sealant paste. Tape can break loose and cause blockages in the hydraulic system.
- Call Pierce
 - In the event you need any assistance please call 800-658-6301.

Official Pierce Arrow Inc. Product Limited Warranty

Pierce Arrow Inc. warrants that the goods, equipment, and merchandise manufactured by Pierce Arrow Inc. are free from defects in material and workmanship. The limited warranty includes replacement or repair of defective mechanical and electrical parts for a period of two years from the date of shipment by Pierce Arrow Inc.

OBTAINING PIERCE WARRANTY SERVICE

Pierce Arrow Inc. must be notified of any defect before repair or replacement may be granted. The merchandise must be delivered by the purchaser to Pierce Arrow Inc. in Henrietta, Texas at the purchaser's expense. Any repairs not made by Pierce Arrow Inc. are not covered by the limited warranty and are the responsibility of the purchaser. Pierce Arrow Inc. reserves the right to repair or replace defective parts or products in its sole discretion. The cost of any repairs not covered by the warranty will be charged to the purchaser.

EXCLUSIONS

All Pierce products are manufactured for a specific intended purpose. The Pierce Arrow Inc. limited warranty does not cover, and Pierce Arrow Inc. is not liable for, damage arising from any use other than the specific intended use of each product.

The Pierce Arrow Inc. limited warranty does not cover: Ongoing maintenance parts or repair due to normal wear and tear, and any change or defect due to accident, misuse or any use for which the equipment was not intended, improper or unauthorized repair, failure to provide regular maintenance, and deterioration due to weather or road conditions. Purchasers should consult their owner's manual for safety, installation, operation, and maintenance guidelines.

The Pierce Arrow Inc. limited warranty does not cover purchaser's cost of labor, transportation, shipping damages, installation or removal costs, down time, loss of profit or goodwill, or any other special, incidental, indirect, or consequential damages, concerning or related to any product or part, whether based upon negligence, strict liability, breach of contract, breach of warranty, misrepresentation, or any other legal theory. Merchandise manufactured by Pierce Arrow Inc. is not designed or intended for the movement of people and are not to be used in the operation of elevators or other improper uses. Any improper use of the product may void the warranty.

OTHER MANUFACTURERS' WARRANTIES

Pierce Arrow Inc. makes no warranty, expressed or implied, to finished products manufactured or supplied by other manufacturers, and sold by Pierce Arrow Inc. to the purchaser, including but not limited to, any vehicle to which our products is affixed and any accessories. Such merchandise is subject to the manufacturer's warranty only, which will be provided upon request.

CONDITIONS OF SALE

When placing an order with Pierce Arrow Inc., the terms and conditions provided for payment, shipping, delivery and claims create an agreement between the purchaser and Pierce Arrow Inc. The agreement is to be performed in Clay County, Texas.

RETURNS

No returns are accepted without prior authorization. All items must be returned in their entirety. Please contact a sales representative for authorization. Upon authorization, returns must be shipped freight prepaid and may be subject to a 15% restocking fee. Please do not send returns COD. No returns will be accepted later than 30 days from the date of invoice.

DAMAGED GOODS

Pierce Arrow Inc. is not responsible for, and has no liability for:

Damage arising during shipment, damage arising during purchaser's assembly, installation, or construction of or with the products, and damage arising from accident, misuse or any use for which the equipment was not intended, improper or unauthorized repair, or weather or road conditions.

CLAIMS

Claims for breakage or damages during shipment must be made to the carrier at the time of delivery. If a signature is required, you must notify the driver and sign that there was damage. You must notify Pierce Arrow Inc. of the damage promptly so that a claim can be filed.