

PIERCE

PULLING FOR YOU

OWNER'S MANUAL PS SERIES WINCHES

PS4000 / PS6000 / PS9000 /
PS12000 / PS20000



REGISTER YOUR PRODUCT!

In order for us to best serve you,
please register your product at
www.piercearrowinc.com/register.

Why register?

- receive product updates via email
- receive maintenance reminders via email
- receive quick technical service help if you encounter a problem

DISCLAIMER

The PS series winch is a powerful tool and must be used with extreme care. Deviating from the manual's instructions may cause personal injury. You may void your warranty if you do not follow the precautions and guidelines outlined in this manual. Keep this manual in a safe place to reference safety and installation instructions, maintenance guidelines and operating recommendations. The owner, operator, and installer must read the entire manual before operating the winch.

SHIPMENT CONTENTS

1 – Winch	2 – Bolts
1 – P040N Three Prong Remote Control	2 – Nuts
4 – Winch Mounting Bolts	2 – Washers
4 – Lock Washers	1 – Wire Rope
1 – Snatch Block	1 – Slip Eye Safety Hook
1 – Solenoid Assembly	1 – Owner's Manual
1 – Roller Guide	

RECOMMENDED TOOLS

- Wrench/Socket
 - PS4000:* 7mm, 13mm
 - PS6000/PS9000/PS12000/PS20000:* 16mm, 18mm, 19mm
- Crowbar
- #2 Phillips Screwdriver (PS4000 only)
- Gloves
- Safety Glasses
- Tree Saver Strap
- Safety Cut Off Switch
- First Aid Kit
- Bow Shackles
- Chains or Straps
- Wheel Blocks or Choks
- Heavy Blanket

SAFETY WARNINGS

DRESS PROPERLY

- DO NOT wear loose fitting clothing or jewelry.
- Tie back long hair.
- Wear leather gloves when handling the wire rope.
- Wear non-skid footwear during winch operation.
- Wear eye and ear protection during operation.

KEEP A SAFE DISTANCE

- DO NOT step over or under the wire rope.
- All onlookers must keep away from the work area.
- Never work on or around the winch drum when the winch is operating.
- DO NOT alter your winch in any way. Alterations may weaken the structural integrity of the winch and void your warranty.
- Operate your winch with an unobstructed view.

SAFETY WARNINGS (continued)

DO NOT MISUSE YOUR WINCH

- DO NOT lift items vertically. The winch was designed for horizontal use only.
- DO NOT operate the winch with less than eight wraps on the drum. The set screw on the drum is not designed to hold pull force of cable.
- Avoid continuous pulls from extreme angles. This will cause the wire rope to jam as it piles up on one side.
- Use a nylon sling when winching. Hooking the wire rope to itself will cause considerable damage to the wire rope.
- DO NOT move your vehicle to assist the winch in pulling the load. The combination of the winch and vehicle pulling could overload the wire rope and winch.
- Never release the free spool clutch when a load is connected to the winch.
- DO NOT exceed pulling limitations of winch.
- DO NOT shock loads when winching. A shock load occurs when increased force is suddenly applied to the wire rope.
- DO NOT use your winch as a hoist.
- DO NOT use your winch to lift, support, or transport people.
- DO NOT alter the warning instruction labels.
- DO NOT overheat your winch. Use your winch intermittently.
- Only use your winch for direct winching. Do not use your winch for jerking loads, towing or securing a load. Any damage incurred as a result of such action will void the warranty.
- DO NOT winch near electrical power lines.

DO NOT ABUSE THE WIRE ROPE

- Never carry your winch by the wire rope.
- Never yank the wire rope from the winch.
- Keep the wire rope from heat or sharp edges.
- **The cable must be spooled from the bottom of the drum.**

DO NOT OVERWORK YOUR WINCH

- DO NOT maintain power if the motor stalls.
- DO NOT exceed maximum line pull ratings.
- DO NOT overload your winch's pulling capacity. We recommend the use of a pulley block to double line the wire rope on heavy loads.
- DO NOT prolong pulls. The electric winch is designed for intermittent use only. If the motor becomes very hot, stop the winch and let it cool down for several minutes.

AVOID UNINTENTIONAL STARTING

- The winch clutch must be disengaged when not in use and fully engaged when in use.
- Power must be disconnected when not in use.

MAINTAIN YOUR WINCH

- Before use, you must check your winch carefully.
- Damaged equipment must be properly repaired or replaced by the manufacturer or an authorized service center.
- Inspect and maintain the wire rope and winch frequently.
- Replace frayed rope strands immediately.
- Use only factory approved switches, remote controls and accessories.
- Check the tightness of the mounting bolts and electrical connections periodically.

RE-SPOOL THE WIRE ROPE

- Wear leather gloves while re-spooling.
- **DO NOT allow the wire rope to thread through your hand without a glove.**
- Keep a slight load on the wire rope while re-spooling. Hold the wire rope with one gloved hand and the remote control in the other.

INSTALLATION

MOUNTING

- Before installation, ensure the mounting frame in use is capable of withstanding the winch's rated capacity.
- Ensure the motor, wire rope, drum and gear housing is properly aligned.
- Mount to a flat surface using 3/8" UNC x 1 1/4" stainless steel bolts and spring washers (PS20000 requires grade 10.9 bolts). Your mounting plate must be 6mm or 1/4" thick. If your mounting plate is thicker than 1/4", lengthen bolts accordingly.
- Mount the roller guide in front of the winch. Do not attach the roller guide to the winch.
- **The cable must be spooled from the bottom of the drum.**
- Do not mount the winch backwards and reinstall cable to come from bottom. It **MUST** be installed as it lays from the factory. (see image below)



ELECTRICAL CONNECTIONS

- Connect the black wire to the ground post (1) on the motor. (see wiring diagram section for details)
- Connect the red wire to any terminal on the safety cutoff switch (PS025). Use the other terminal to connect to the vehicle's battery.
- Your solenoid comes pre-wired. (see wiring diagram section for details)

WIRE ROPE PREPARATION

NOTE: The first use of your winch must be a test run during a non-recovery situation. During this trial run begin to recognize the sound of a steady pull, a heavy pull, load jerking or shifting.

- Spool the wire rope.
- Wear leather gloves while spooling. **DO NOT allow the wire rope to thread through your hand without a glove.**
- Unwind the wire rope carefully along the floor to avoid kinking.
- Place the end of the wire rope in to the hole on the side of the drum. The wire rope will protrude 1/2"- 1". Tighten the set screw.
- Keep a slight load on the wire rope while spooling.
- Using the remote control, wrap the wire rope on to the drum until the load is recovered. During operation, make sure the wire rope lays smoothly on to the drum without spacing or overlapping.
- Spool the wire rope until the red mark appears at five wraps.
- Under a load of 500 lbs (230 kg) re-spool the wire rope. This will stretch the new wire rope and create a tight wrap around the drum.

NOTE: The wire rope should not make contact with the cross bars that hold the two halves of the winch together.

OPERATION

- Apply the parking brake or lock the wheels.
- While the clutch is in the OUT position, spool the winch cable and connect to an anchor point.
- Check cable rigging before proceeding.
- Plug in the winch remote control.
- Engage the clutch by shifting it into the IN position. **NOTE:** When the clutch is engaged, your load may begin to drift until the remote is used to recover your load. To ensure safe operation, it is recommended that winch operation take place from the driver's position.
- Start vehicle engine, select neutral or park and maintain idle engine speed.
- Using the remote control, press IN or OUT until the vehicle has been retrieved. Regularly check the winch to ensure the cable is winding onto the drum evenly. It is recommended you secure the load using chains or straps at this point.
- Detach the load.
- Re-spool the wire rope after winch operation is complete.

MAINTENANCE

NOTE: It is highly recommended that you regularly use your winch. Simply power the cable out 15 feet, free spool five feet and power in. This will keep all components in good condition so that the winch can be ready when needed. Contact the manufacturer or authorized outlet for technical assistance and repairs.

LUBRICATION

- The gearbox has been lubricated using high temperature lithium grease at the factory. No internal lubrication is required.
- Lubricate cable periodically using light penetrating oil. Inspect for broken or worn strands and replace if necessary.

BATTERY

- Be sure the battery is in working condition.
- Avoid contact with battery acid.
- Wear eye protection when working around the battery.
- Avoid depleting the battery by running the engine when using the winch.
- Check terminals for corrosion and clean or replace as needed.

ELECTRICAL CONNECTIONS

- Remove dirt or grease that may have accumulated on the electrical connections.
- Dielectric grease is recommended on terminals and plugs.

ROPE

- Use aircraft grade cable or approved and rated synthetic rope.
- The life of the rope is directly related to the use and care it receives.
- Replace damaged or frayed rope with manufacturer's identical replacement part.
- Be sure the rope is in good condition and is properly attached.
- DO NOT use the winch if the rope is frayed.
- DO NOT replace the cable with a cable of lesser strength.
- When the rope is replaced, apply Loctite 7471 primer or 222 Threadlocker to the wire rope clamp to prevent loosening of the screw.

SPARE PARTS

- A comprehensive range of spare parts is available. Please contact the manufacturer, Pierce Arrow at 940-538-5643 for more information.
- DO NOT attempt to disassemble the gearbox. Disassembly may void the warranty. Call Pierce Arrow at 940-538-5643 before repairs are made.

SPECIFICATIONS

	PS4000	PS6000	PS9000	PS12000	PS20000
RATED LINE PULL	4,000 lbs	6,000 lbs	9,000 lbs	12,000 lbs	20,000 lbs
LINE SPEED	19.6 fpm	13.0 fpm	24.0 fpm	21.3 fpm	20.4 fpm
VOLTAGE	12V	12V	12V	12V	12V
CONTROL	remote with 15' lead and handle bar switch	remote with 15' lead	remote with 15' lead	remote with 15' lead	remote with 15' lead
RATIO	136:1	218:1	265:1	265:1	420:1
RECOMMENDED BATTERY	650 CCA	650 CCA	650 CCA	650 CCA	650 CCA
MINIMUM WIRE GAUGE	4 gauge	2 gauge	2 gauge	2 gauge	2 gauge
MOTOR	1.3 hp	5.5 hp	5.5 hp	5.5 hp	6.8 hp
WINCH CONSTRUCTION	cast metal	cast metal	cast metal	cast metal	cast metal
GEAR TRAIN	3-stage planetary	3-stage planetary	3-stage planetary	3-stage planetary	3-stage planetary
CLUTCH	cam	sliding ring gear	sliding ring gear	sliding ring gear	sliding ring gear
BRAKE	dynamic	automatic in the drum	automatic in the drum	automatic in the drum	automatic in the drum
ROTATION OF WINCH	CCW	CCW	CCW	CCW	CCW
DRUM SIZE	2.00" x 2.90"	2.50" x 5.25"	2.50" x 8.70"	2.50" x 8.70"	3.50" x 8.70"
MOUNTING PATTERN	3.0" x 4.8"	4.5" x 6.625"	4.5" x 10"	4.5" x 10"	4.5" x 10"
RECOMMENDED WIRE ROPE	1/4" x 40'	9/32" x 65'	3/8" x 94'	3/8" x 94'	1/2" x 72'
WINCH WEIGHT	19 lbs	55 lbs	84 lbs	88 lbs	132 lbs
GROSS WEIGHT	31 lbs	77 lbs	91 lbs	98 lbs	146 lbs
WINCH DIMENSIONS (LxWxH)	15" x 7" x 7"	17.625" x 5.375" x 8.75"	21" x 5.375" x 8.75"	21" x 5.375" x 8.75"	21.875" x 6.5" x 11.125"
BOX DIMENSIONS (LxWxH)	16.25" x 11" x 6.75"	23" x 8.5" x 14"	23" x 8.5" x 14"	23" x 8.5" x 14"	25" x 10.25" x 16.5"

SPECIFICATIONS *(continued)*

	LAYERS OF WIRE ROPE	RATED PULL (LB)	WIRE ROPE (FT)	LINE PULL (LB)	SPEED (FPM)	CURRENT (AMPS)	
PS4000	1	4,000	9.8	0	19.6	11	
	2	3,264	22	1,000	10.8	40	
	3	2,760	36	2,000	7.5	70	
	4	2,388	50	3,000	5.9	95	
				4,000	3.6	310	
PS6000	1	6,000	13	0	21.3	65	
	2	4,990	29	1,000	11.5	126	
	3	4,280	48	2,000	9.4	175	
	4	3,780	69	4,000	7.9	230	
	5	3,310	79	6,000	6.5	280	
PS9000	1	9,000	16.2	0	24.0	80	
	2	7,320	39.3	4,000	10.6	240	
	3	5,500	68.9	6,000	8.5	280	
	4	4,750	91.8	8,000	7.0	330	
				9,000	6.5	360	
PS12000	1	12,000	17	0	21.3	65	
	2	9,210	41	4,000	9.4	175	
	3	8,030	71	6,000	7.9	230	
	4	6,894	85	8,000	6.5	280	
				12,000	4.4	390	
PS20000	1	20,000	20.4	0	23.9	68	
	2	15,482	42.4	6,000	7.4	185	
	3	12,584	60.2	10,000	5.1	275	
	4	10,550	72.2	15,000	3.3	435	
				20,000	2.62	530	

WIRING DIAGRAMS

Use the diagram below to set up your PS4000 winch wiring.

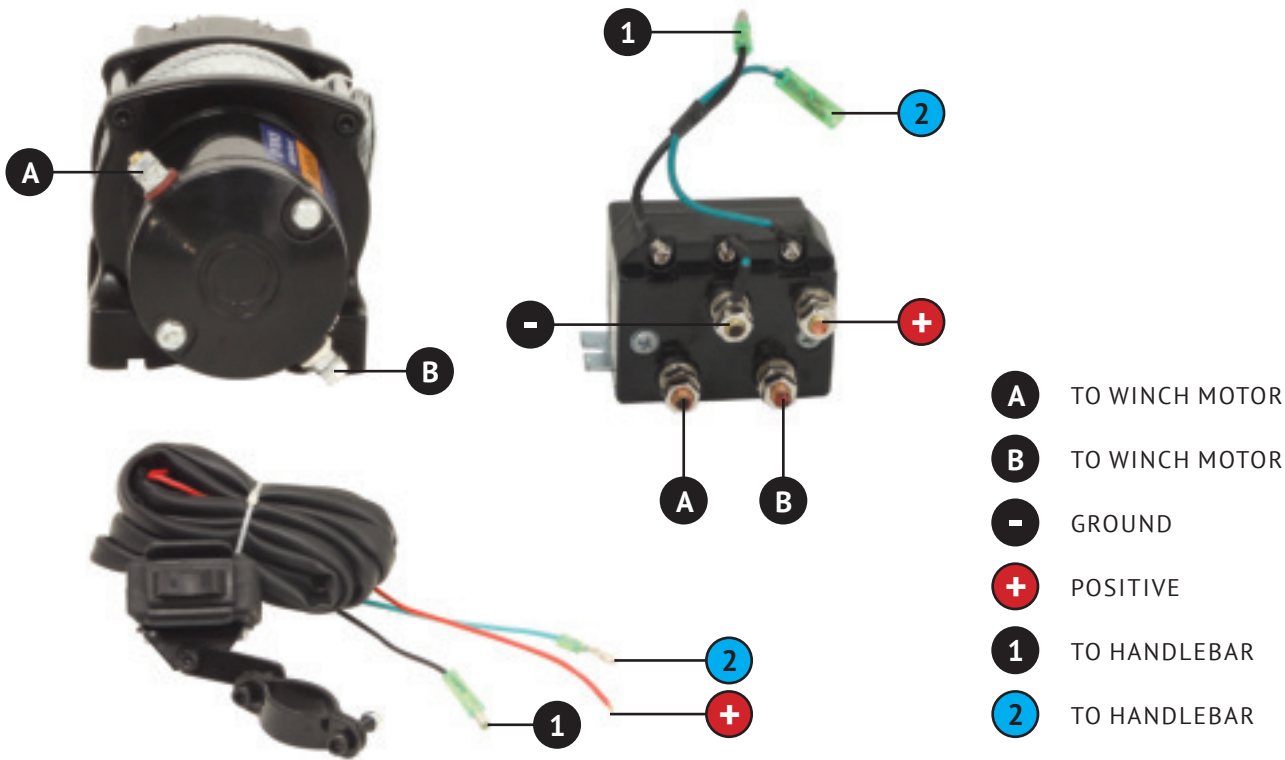

Use the diagram below to set up your PS6000, PS9000, PS120000, or PS20000 winch wiring.

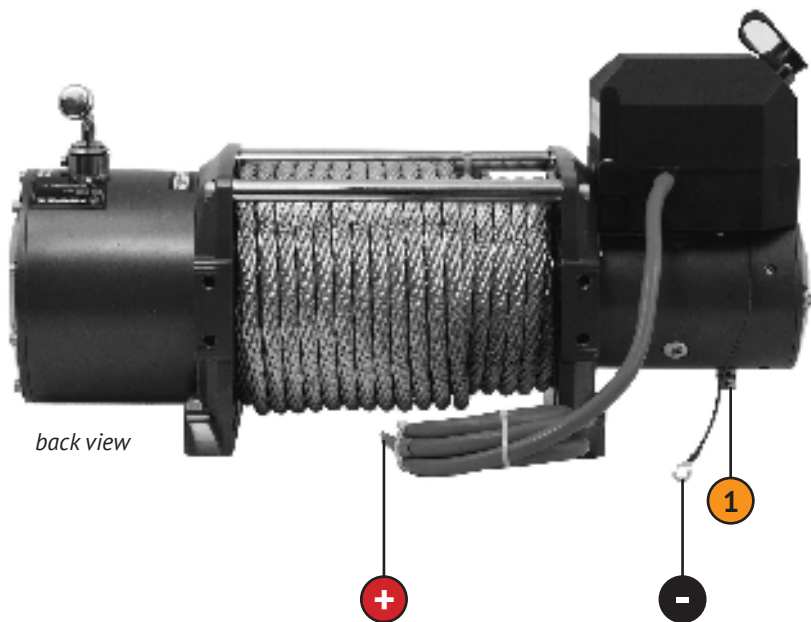

PS025 Safety Cut Off Switch









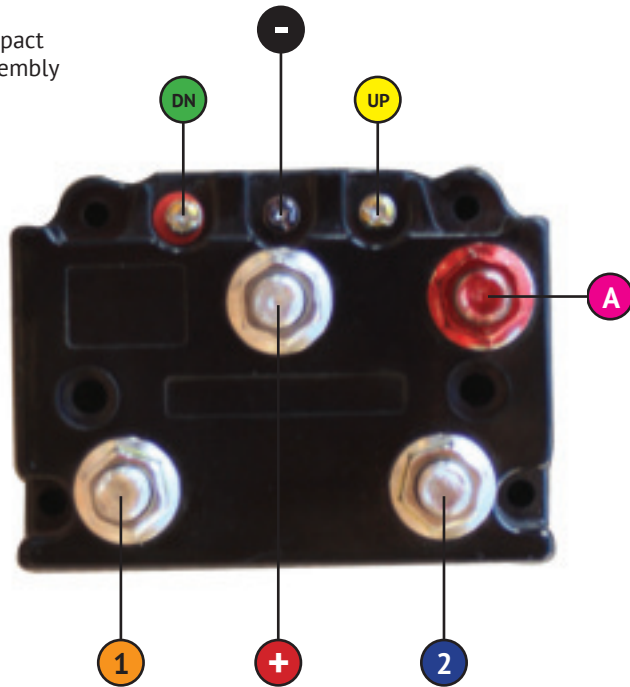

- +** POSITIVE TO SAFETY CUT OFF SWITCH
- GROUND
- 1** WINCH POST GROUND

WIRING DIAGRAMS *(continued)*

Use the diagram below to customize your wired or wireless remote control connections.

PS528N Compact Solenoid Assembly



-  12V
-  GROUND
-  TO REMOTE DOWN
-  TO REMOTE UP
-  FIELD 1
-  FIELD 2
-  ARMATURE POST



PARTS DIAGRAMS

PS4000

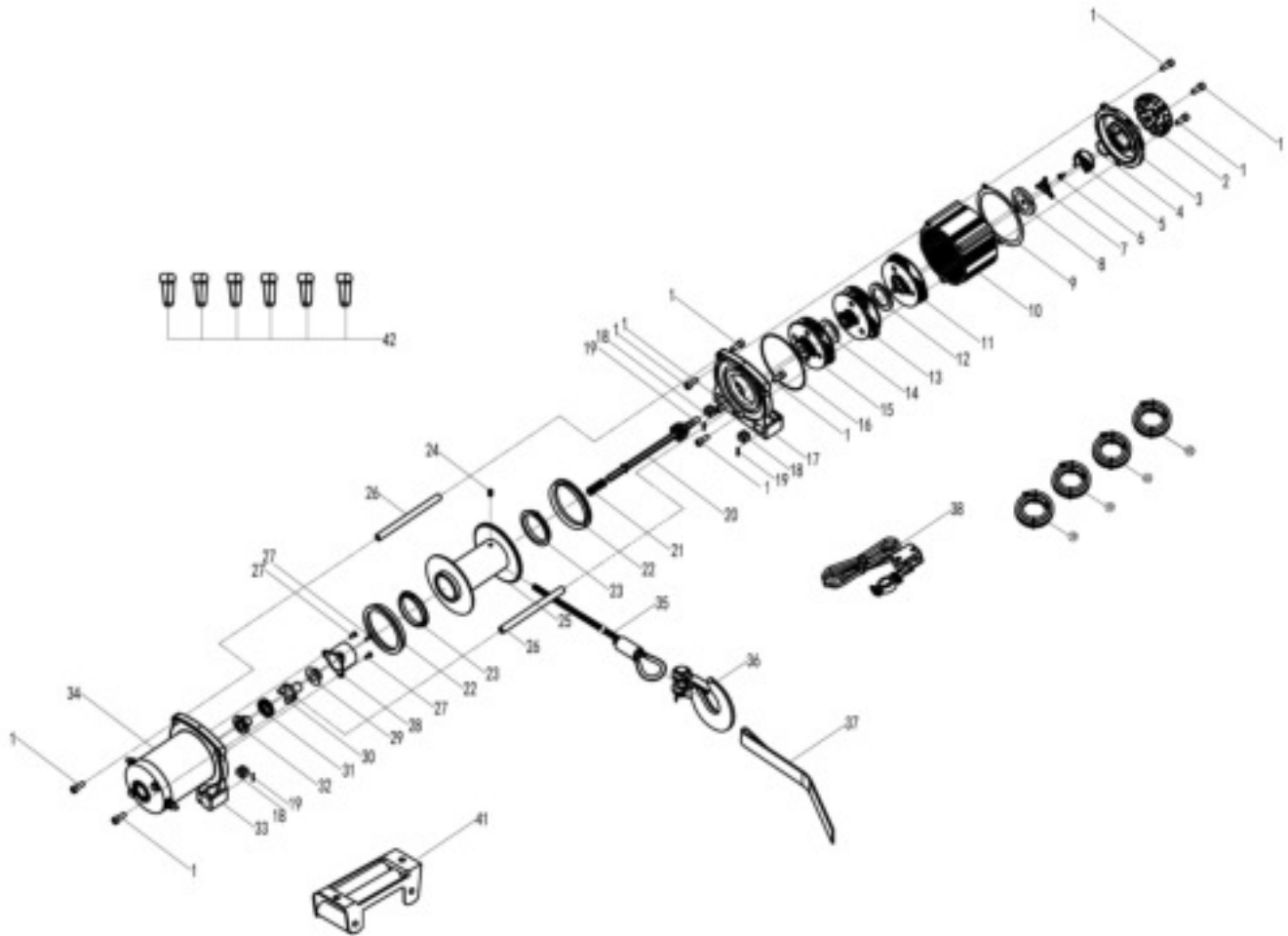

NUMBER	DESCRIPTION	NUMBER	DESCRIPTION	NUMBER	DESCRIPTION
1	Hex socket screw M6x18	15	Tertiary planetary gear set	28	Break cover
2	Round cover handle bar	16	O-ring 98.6x95x1.8	29	Break fork positioning ring
3	Gearbox rear cover	17	Gearbox support	30	Break fork
4	O-ring 26x1.5	18	Square nut M8x14x8	31	Break torsion spring
5	Fixing base	19	Elastic cylindrical pin	32	Break base
6	Tapping screw M4x8 (with shim)	20	Spline drive shaft assembly	33	Motor support
7	Rotating piece	21	Clutch spring	34	Motor assembly
8	Gearbox cover inner lining	22	Flat sealing ring	35	Steel cable assembly
9	Gearbox rear cover scaling	23	Sliding bearing	36	Hook G70 ¼
10	Inner gear cylinder	24	Tightening screw M6x10 (chamfered hex socket)	37	Warning tape
11	Primary planetary gear set	25	Spool	38	Handle bar switch
12	Primary side plate spacer	26	Support shaft	39	Battery cable - anode
13	Secondary planetary gear set	27	Cross recessed screw M4x10	40	Battery cable - cathode
14	Secondary side plate spacer			41	Fairlead
				42	Waterproof cover

PARTS DIAGRAMS

PS6000

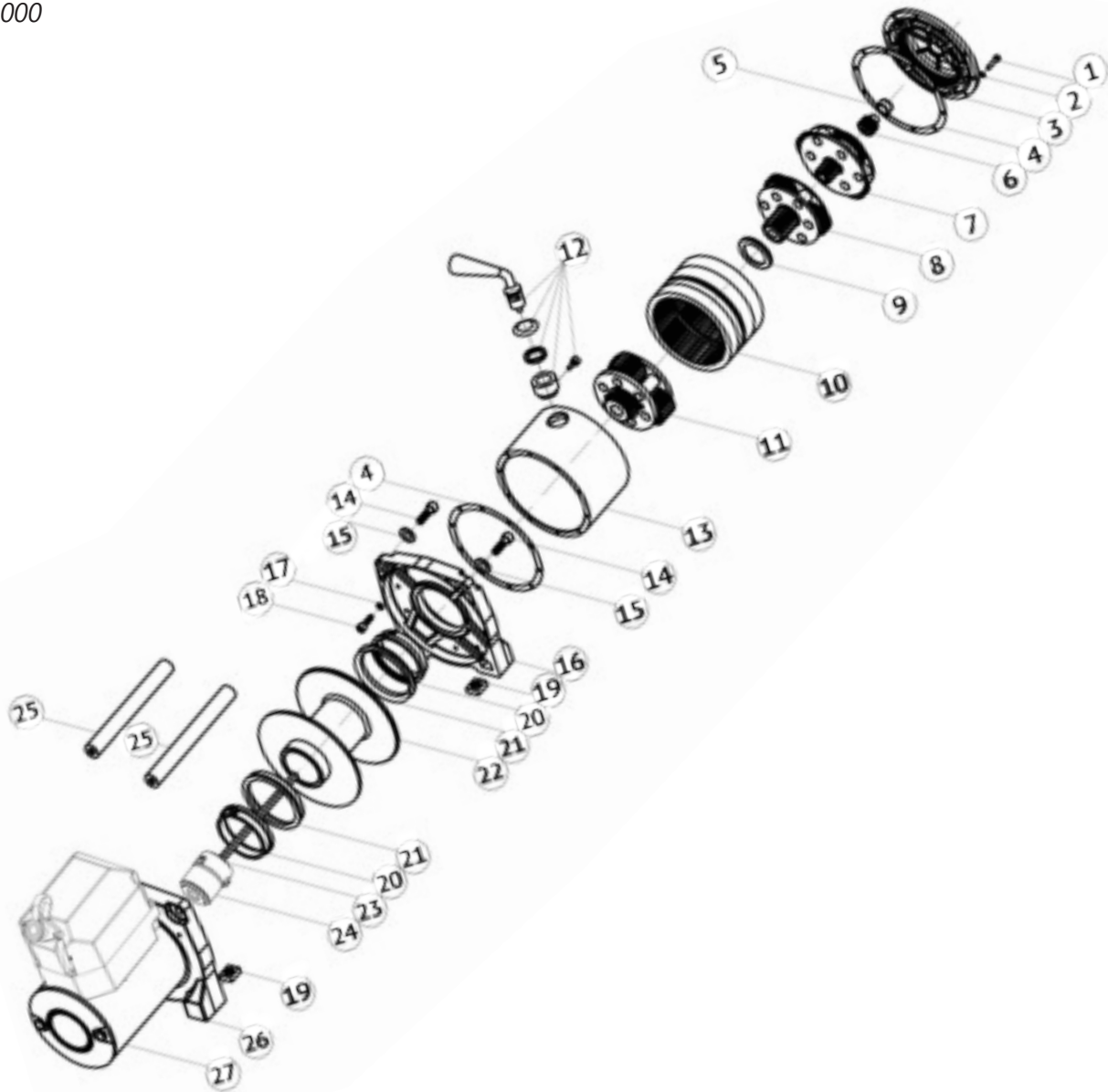

NUMBER	DESCRIPTION	NUMBER	DESCRIPTION	NUMBER	DESCRIPTION
1	Screw M4x18	10	Ring gear	19	Nut
2	Spring washer	11	Stage 3 of planet wheel	20	Sliding bearing
3	Gearbox endcap	12	Clutch set	21	Seal ring
4	Washer	13	Gearbox tube	22	Drum assembly
5	Oil-retaining bearing	14	Screw	23	Drive shaft
6	Allen center wheel	15	Washer	24	Brake assembly
7	Stage 1 of planet wheel	16	Gearbox base	25	Tie bar
8	Stage 2 of planet wheel	17	Spring washer	26	Motor
9	Washer	18	Screw M4x18	27	Cross recessed screw M4x10

PARTS DIAGRAMS

PS9000 / PS12000

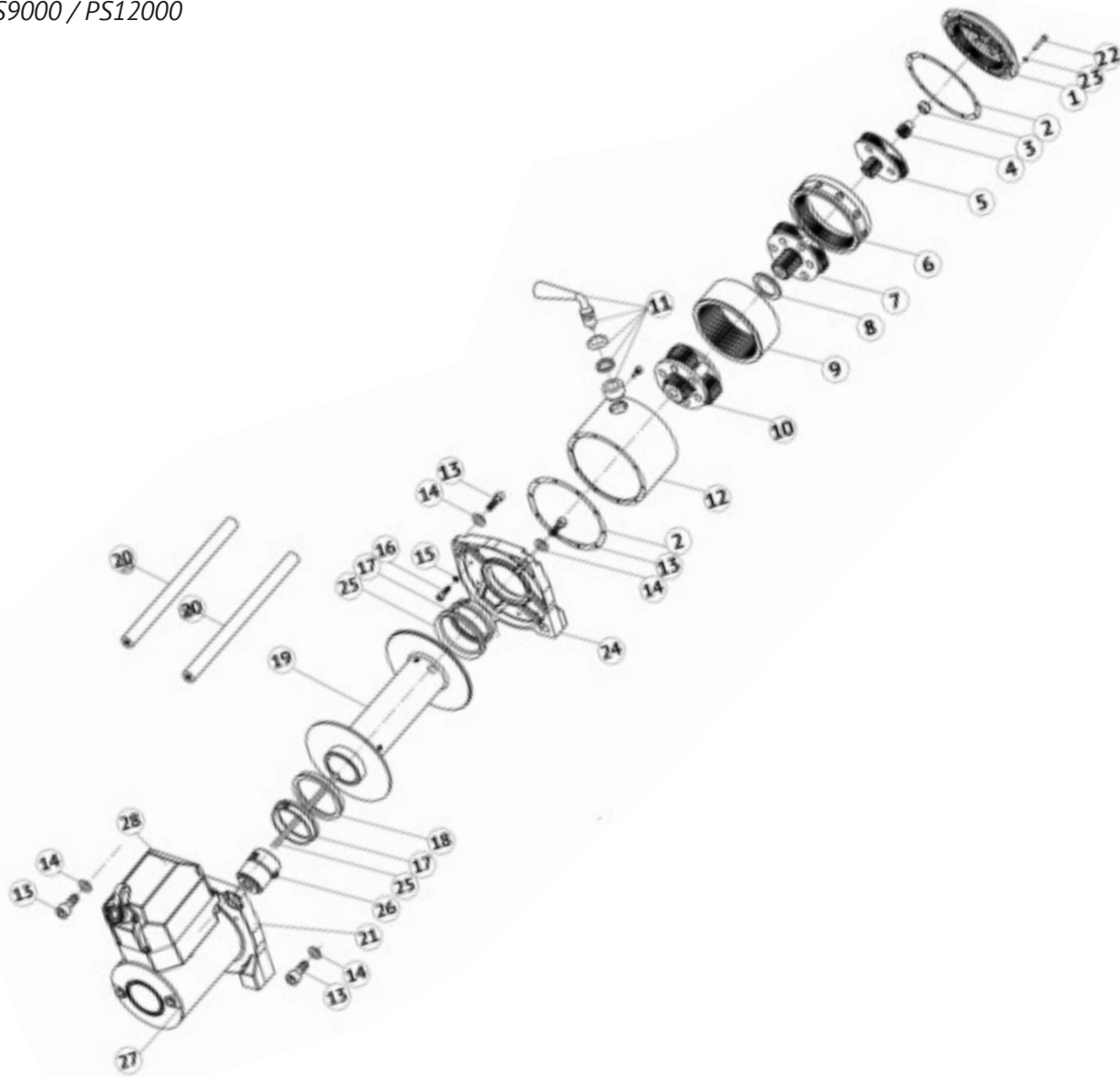

NUMBER	DESCRIPTION	NUMBER	DESCRIPTION	NUMBER	DESCRIPTION
1	Gearbox endcap	11	Clutch set	20	Tie bar
2	Washer	12	Gearbox tube	21	Motor base
3	Oil-retaining bearing	13	Hexagon socket head cap screw	22	Hexagon socket head cap screw
4	Allen center wheel	14	Gasket	23	Spring washer
5	Stage 1 of planet wheel	15	Spring washer	24	Gearbox base
6	Clutch gear	16	Hexagon socket head cap screw	25	Drive shaft
7	Stage 2 of planet wheel	17	Sliding bearing	26	Brake assembly
8	Washer	18	Seal ring	27	Motor
9	Stationary gear	19	Drum assembly	28	Control box
10	Stage 3 of planet wheel				

PARTS DIAGRAMS

PS20000

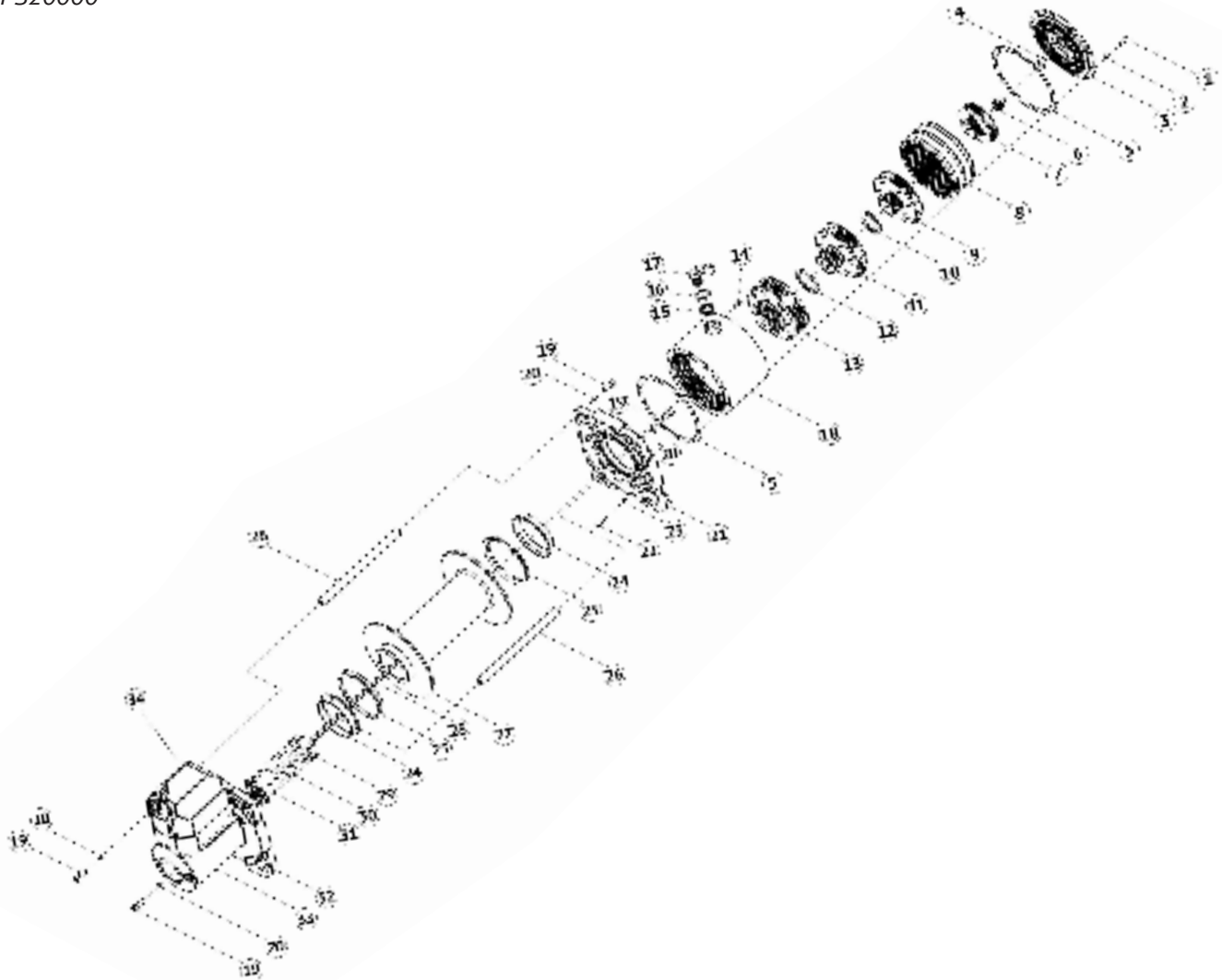

NUMBER	DESCRIPTION	NUMBER	DESCRIPTION	NUMBER	DESCRIPTION
1	Screw M5x16	13	Stage 4 of planet wheel	24	Axle sleeve
2	Spring washer	14	Spacing screw	25	Seal ring
3	Gearbox endcap	15	Washer	26	Tie bar
4	Oil-retaining bearing	16	Endcap	27	Drum assembly
5	Washer	17	Clutch set	28	Drive shaft
6	Allen center wheel	18	Gearbox tube	29	Screw M4x16
7	Stage 1 of planet wheel	19	Screw M8x25	30	Spring washer
8	Ring gear	20	Spring washer	31	Brake assembly
9	Stage 2 of planet wheel	21	Gearbox base	32	Motor base
10	Washer	22	Screw M5x16	33	Motor
11	Stage 3 of planet wheel	23	Spring washer	34	Control set
12	Washer				

LIMITED WARRANTY

Pierce Arrow Inc. warrants that the goods, equipment, and merchandise manufactured by Pierce Arrow Inc. are free from defects in material and workmanship. The limited warranty includes replacement or repair of defective mechanical and electrical parts for a period of one year from the date of shipment by Pierce Arrow Inc.

OBTAINING WARRANTY SERVICE

Pierce Arrow Inc. must be notified of any defect before repair or replacement may be granted. The merchandise must be delivered by the purchaser to Pierce Arrow Inc. in Henrietta, Texas at the purchaser's expense. Any repairs not made by Pierce Arrow Inc. are not covered by the limited warranty and are the responsibility of the purchaser.

Pierce Arrow Inc. reserves the right to repair or replace defective parts or products in its sole discretion. The cost of any repairs not covered by the warranty will be charged to the purchaser.

EXCLUSIONS

All Pierce products are manufactured for a specific intended purpose. The Pierce Arrow Inc. limited warranty does not cover, and Pierce Arrow Inc. is not liable for, damage arising from any use other than the specific intended use of each product.

All coolers manufactured by Pierce are warranted for general cooling, and are not guaranteed to produce cooling sufficient for any specific purpose or for specific temperature. Pierce is not liable for any injury or damage arising from insufficiently cooled objects placed in the cooler, including but not limited to medications and perishables.

The Pierce Arrow Inc. limited warranty does not cover:

- Ongoing maintenance parts or repair due to normal wear and tear, and
- Any change or defect due to accident, misuse or any use for which the equipment was not intended, improper or unauthorized repair, failure to provide regular maintenance, and deterioration due to weather or road conditions.

Purchasers should consult their owner's manual for safety, installation, operation, and maintenance guidelines.

The Pierce Arrow Inc. limited warranty does not cover purchaser's cost of labor, transportation, shipping damages, installation or removal costs, down time, loss of profit or goodwill, or any other special, incidental, indirect, or consequential damages, concerning or related to any product or

part, whether based upon negligence, strict liability, breach of contract, breach of warranty, misrepresentation, or any other legal theory.

Merchandise manufactured by Pierce Arrow Inc. is not designed or intended for the movement of people and are not to be used in the operation of elevators or other improper uses. Any improper use of the product may void the warranty.

OTHER MANUFACTURERS' WARRANTIES

Pierce Arrow Inc. makes no warranty, expressed or implied, to finished products manufactured or supplied by other manufacturers, and sold by Pierce Arrow Inc. to the purchaser, including but not limited to, any vehicle to which our product is affixed and any accessories. Such merchandise is subject to the manufacturer's warranty only, which will be provided upon request.

CONDITIONS OF SALE

When placing an order with Pierce Arrow Inc., the terms and conditions provided for payment, shipping, delivery and claims create an agreement between the purchaser and Pierce Arrow Inc. The agreement is to be performed in Clay County, Texas.

RETURNS: No returns are accepted without prior authorization. All items must be returned in their entirety. Please contact a sales representative for authorization. Upon authorization, returns must be shipped freight prepaid and may be subject to a 15% restocking fee. Please do not send returns COD. No returns will be accepted later than 30 days from the date of invoice.

DAMAGED GOODS: Pierce Arrow Inc. is not responsible for, and has no liability for:

- Damage arising during shipment
- Any change or defect due to accident, misuse or any use for which the equipment was not intended, improper or unauthorized repair, failure to provide regular maintenance, and deterioration due to weather or road conditions.

CLAIMS: Claims for breakage or damages during shipment must be made to the carrier at the time of delivery. If a signature is required, you must notify the driver and sign that there was damage. You must notify Pierce Arrow Inc. of the damage promptly so that a claim can be filed.

Thank you for choosing Pierce!

We strive to offer 100% customer satisfaction on all our products. We are committed to excellent customer service because we are *pulling for you*.

SHARE YOUR FEEDBACK

Are you 100% satisfied?

- **If YES:** Please write a review on our Facebook page. www.facebook.com/piercearrowinc
- **If NO:** Call us at 800-658-6301 or let us know how we can help at www.piercearrowinc.com/contact-us

STAY IN TOUCH

Pierce Arrow Inc.
549 US Highway 287 South
Henrietta, Texas 76365

Toll Free: (800) 658-6301
Local: (940) 538-5643
Fax: (940) 538-4382

www.piercearrowinc.com
www.youtube.com/piercearrowinc