

# **DK2UFKPD**

# **PIERCE**

**FORD 1999-2016**  
**2-TON DUMP HOIST**

## **Installation Instructions & Owner's Manual**

Please thoroughly read all instructions before beginning installation.

For technical help, call the tech support office at 800-658-6301

Monday-Friday 8:00AM to 5:00PM Central Time

**[WWW.PIERCEARROWINC.COM](http://WWW.PIERCEARROWINC.COM)**

# DK2UFKPD Parts Listing

1 PM-3551 Hydraulic Pump (gravity down option will contain PM-319 Hydraulic Pump)

1 Scissor Assembly (Contains red scissor frame and hydraulic cylinder)

1 Upper Frame "A" (Blue)

1 Upper Frame "B" (Blue)

1 Lower Frame for Long Bed (Blue) (Cut when used in short bed applications)

2 Bed Reinforcement Angle (Blue)

1 Fuel Filler Pipe (9" x 22" aluminum pipe) (Not required in short bed applications)

1 Parts box

- Installation/Owner's Manual
- Electrical/Hydraulic/Hardware Bag

## Electrical

- 20' #4 Black Wire
- 20' #4 Red Wire
- 6x 5/16" Battery Eye
- 1x 200 Amp Breaker
- 1x 2-Button Pendant Control

## Hydraulic

- 1x 5' Hydraulic Hose
- 1x 7' Hydraulic Hose
- 1x 90° ¼" Pipe Pump Fitting (Standard only with gravity down kits)
- 2x 90° O-Ring Pump Fitting

## Hardware

- 2x Hex Screw, 5/8"-11 x 2-1/2" Grade 8
  - 2x Flat Washer, 5/8"
  - 2x Lock Nut, 5/8"-11 Grade 8
  - 12x Hex Screw, 3/8"-16 x 1" Grade 8
  - 12x Hex Screw, 3/8"-16 x 1.5" Grade 8
  - 33x Lock Nut, 3/8"-16 Grade 8
  - 7x Hex Screw, 3/8"-16 x 3" Tap Bolt
  - 4x Hex Screw, 3/8"-16 x 2.5"
  - 2x Flat Washer, 3/8"
  - 4x Cotter Pin, 1/8" x 2"
  - 2x 1/8" Cable Clamp
  - 2x Rubber Bumper
  - 2x 2" Hose Clamp
  - 1x 3" Hose Clamp
  - 1x Scissor Support Cable
- 
- Steel Parts Assortment
    - 1x Right Hinge (Black, 5" x 4", w/Welded Pipe)
    - 1x Left Hinge (Black, 5" x 4", w/Welded Pipe)
    - 2x Hinge Arm (Blue, L-Bracket, 5.25" x 3")
    - 1x Upper Frame Hinge (Blue, 9-3/8" x 4")
    - 1x Lower Shaft (15/16" x 8.75")
    - 1x Upper Shaft (15/16" 10-1/8")
    - 2x Guides (Black, Parallelogram, 6" x 1.5")
    - 1x Pump Bracket (Black, L-Bracket, 7" x 6")
    - 1x Filler Bracket (Blue, Z-Bracket 7" x 7.75" x 5")



Bed Guides



Left & Right  
Frame Hinges

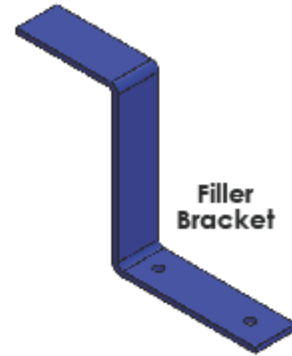

Filler  
Bracket

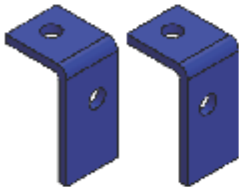

Left & Right  
Bed Hinge

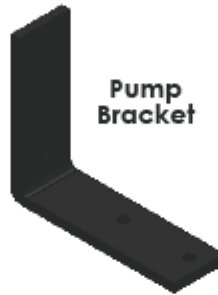

Pump  
Bracket

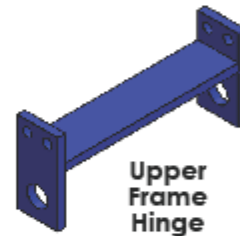

Upper  
Frame  
Hinge



Filler  
Extension

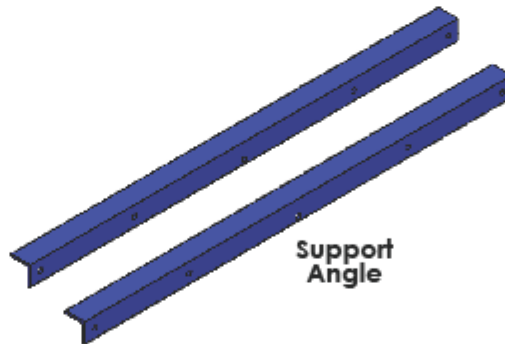

Support  
Angle

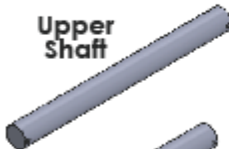

Upper  
Shaft

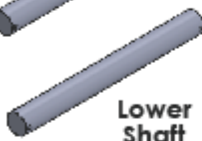

Lower  
Shaft

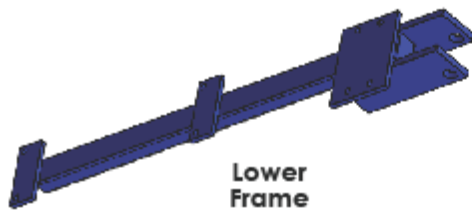

Lower  
Frame

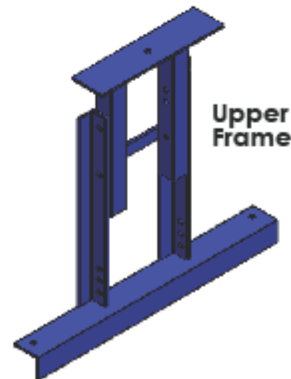

Upper  
Frame

# Important Safety Rules

- Follow all safety rules provided with the power tools used to install your kit.
- Use correctly sized lifting equipment to raise the bed of your truck.
- Always have a backup device in place when working under the bed on your truck. This is in addition to the primary hoist or prop mechanism.
- Wear safety glasses.
- Use UL rated grounded electrical cords and tools.
- Your gas tank is located very close to the scissors and other kit components. Cover with a fireproof tarp and do not allow any sparks in this area. Clean any spills with water.
- Check bed clearance after the hinges are installed to ensure that the bed will not hit the cab during operation.
- Always level the load in your bed.
- Be sure no one is close enough to be injured when you dump the load from your bed.
- Do not exceed the cargo capacity as listed by the truck manufacturer. The kit will lift a level, evenly distributed load of 4000 lbs., including the weight of the bed.
- Dump the load in your truck when your truck is level.
- Grease pins and all moving components monthly.
- Tow trailers only with an appropriated classified receiver hitch. Do not use the bumper for any towing.

# Tools and Equipment

Hacksaw or reciprocating saw

Welder or weld shop availability

Correctly rated hoist or lifting device

Cutting torch

Portable electric drill and various sized drill bits

Various sockets, T50 Torx bit socket (impact rated will help), wrenches and a slotted screwdriver

Tape measure

C Clamps and vise grips

Safety glasses

Welders mask/helmet

1 gallon of automatic transmission fluid

## INSTALLATION OVERVIEW

Read all safety rules. Check the parts list. Disconnect the battery. Remove your bumper. Remove the gas filler from the bed. Disconnect or remove wiring between the frame and the bed. Remove or shorten any spare tire lowering device that would interfere with bed rotation. Remove the bolts holding the bed to the frame. It is not necessary to completely remove your bed. It must be raised high enough in the rear to install the hinges safely. Install the hinges per the directions provided later in this manual. Install the upper frame between the two bed cross members located directly above the main frame. The main frame cross member is located near the front spring hangers for the rear suspension. The left to right position for the upper frame should be as close to the truck centerline as possible, but offset enough that the scissors assembly will clear the gas tank by  $\frac{1}{2}$ " or more. See the directions provided later. The scissors will extend rearward, towards the differential assembly. Move any brake lines from the top of the differential to a point lower than the top surface of the differential. This will prevent any accidental damage to your brake system. Always check clearance of brake lines and electrical components to prevent any accidental damage. The position of the scissor assembly will be adjusted up and down by either moving the scissor assembly fore or aft. When the bed is down, the scissor assembly is about level. We provide a cable to support the back end of the scissor to prevent excess movement up/down when your truck hits bumps.

# INSTRUCTIONS FOR 1999-2016 FORD HOIST

## NOTE\*

Due to clearance from the bed to the cab, this kit will not work on F-150 trucks.

## REAR HINGES:

The bed is connected to the rear of the frame by a 14MM bolt and a semi-captive nut. The goal is to attach the captive nut onto the hinge and to have the captive nut connect with the bed bolt in the original position.

The hinge arms blue and have a 1" hole in each leg. The short leg attaches to the bottom of the bed and the long leg extends vertically along the outside of the frame rail. The hole in the long leg is the pivot hole that must be aligned with the welded pipe on the hinge.

Remove the rear bumper and bed bolts. Raise the bed for access to the rear of the frame rails. Cut a  $\frac{3}{4}$ " x 2.5" notch in the top of the frame. Using the original bed to frame bolt and the captive nut, attach the hinge arm to the bottom of the bed. The pivot hole in the long leg of the hinge arm is not centered. The pivot hole is offset to the rear of the truck it is closer to the tailgate end of the hinge arm. Lower the bed and reattach it in its original position. Mark through the pivot hole onto the frame rail. Cut a 1.25"-1.5" diameter clearance hole in the frame rail. Place the black hinge inside the frame rail with the welded pipe extending from inside to out. Install the  $\frac{5}{8}$ " pivot bolt through the mounting holes in the hinge onto the frame rail. Drill the frame rail for (4)  $\frac{3}{8}$ " x 1" bolts on each side. The heads must be on the outside of the frame with the locknuts on the hinge side. Tighten the rear bed bolts at the top of the hinge arms. Tighten the hinge bolts. Remove all other bed bolts. The bed can now pivot.

### Hinge Modifications To End Of Rear Frame

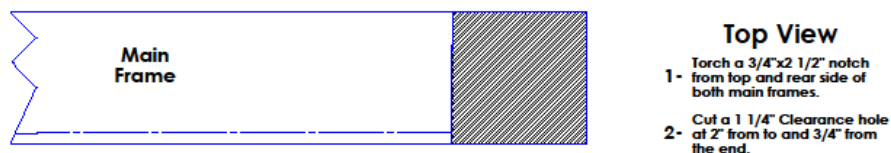
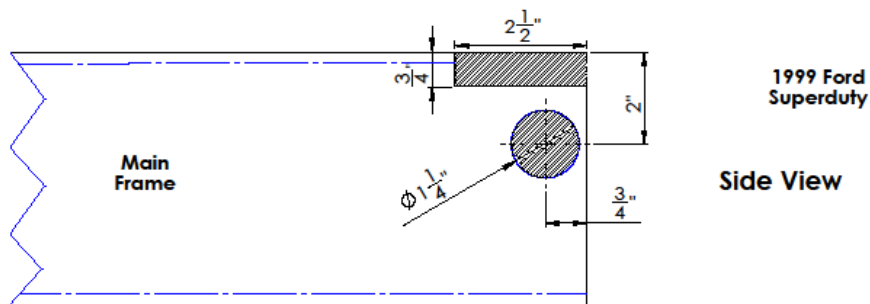

## **LOWER FRAME:**

To begin working with the lower frame, you will see two flat tabs That will need to mount to the truck's cross member. The tab at the end of the channel is for mounting to a long bed truck. The tab in the middle is for mounting to a short bed truck. If you have a short bed, you will need to cut the excess material on the lower frame.

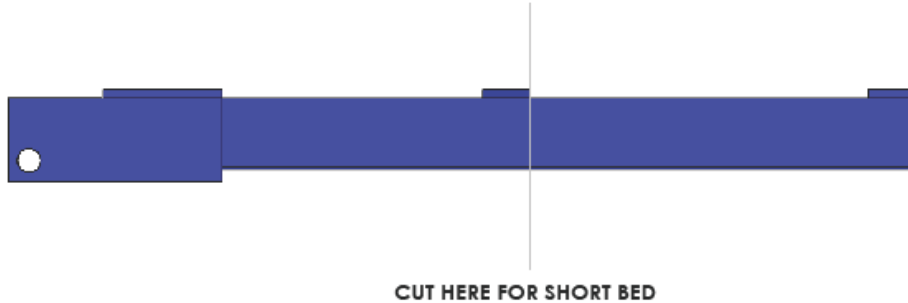

The lower frame/upper frame/scissor assembly should be as close to the truck centerline as possible, but still clear the fuel tank. It will be offset from center, but parallel to the centerline. On most 2004 and newer trucks, the offset will be about 3", up to 5", off center. The fuel tank strap connects to the chassis cross member, interfering with the lower frame. Remove the strap bolt and captive nut. Reattach it with two washers in the large square hole that is closer to the tank. Drill and bolt the lower frame to the chassis cross members. The small end at the end of the channel will attach near the cab of the truck. Note that moving the lower frame rearward will push the scissor assembly up away from the rear end.

Note\* On 2011 and newer diesel trucks, there may be an exhaust mount on the main frame cross member that interferes with the mounting plate on the lower frame. Some bending of the exhaust mount rods may be necessary to move the exhaust pipe outward from the truck centerline.

Note\* In 2012, an emissions tank was added behind the fuel tank. The support bracket must be trimmed to clear the lower frame (and the upper frame). The trimmed support bracket will still provide proper support for the emissions tank.



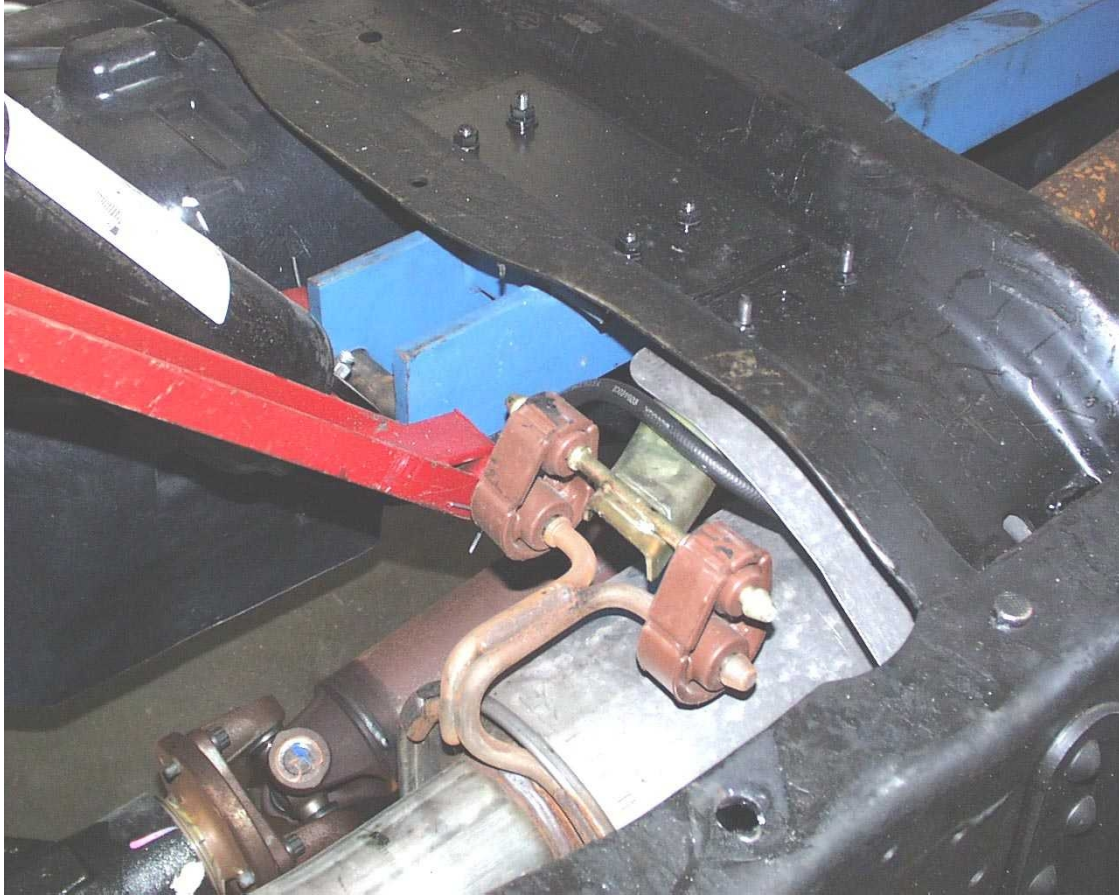

### **SCISSOR ASSEMBLY:**

Remove the galvanized cover above the rear end for scissor clearance. Move the brake line from the top of the differential to behind the differential, well below the top rear cover bolts. Tie or clamp the lines securely to ensure there will be no contact with the scissor assembly. Attach the bottom section of the scissor assembly to the lower frame using the 15/16" x 8.75" pin. Remove the plastic plug from the hydraulic port and open the scissor assembly. Attach the top portion of the scissor assembly to the upper frame hinge and secure with the 15/16" x 10-1/8" pin.

## SHORT BED

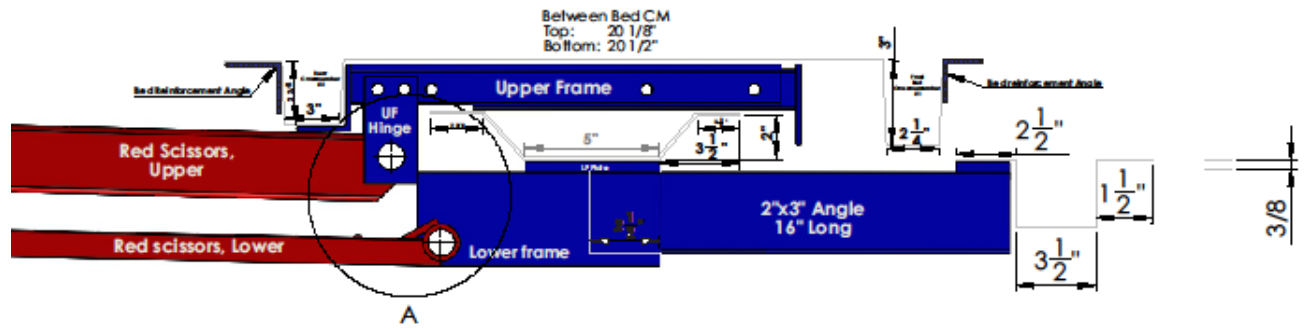

## LONG BED

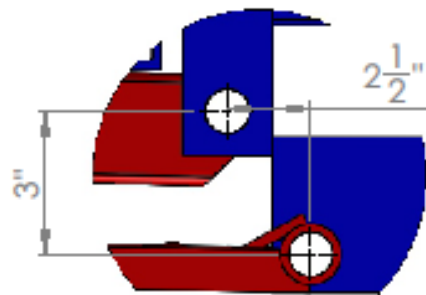
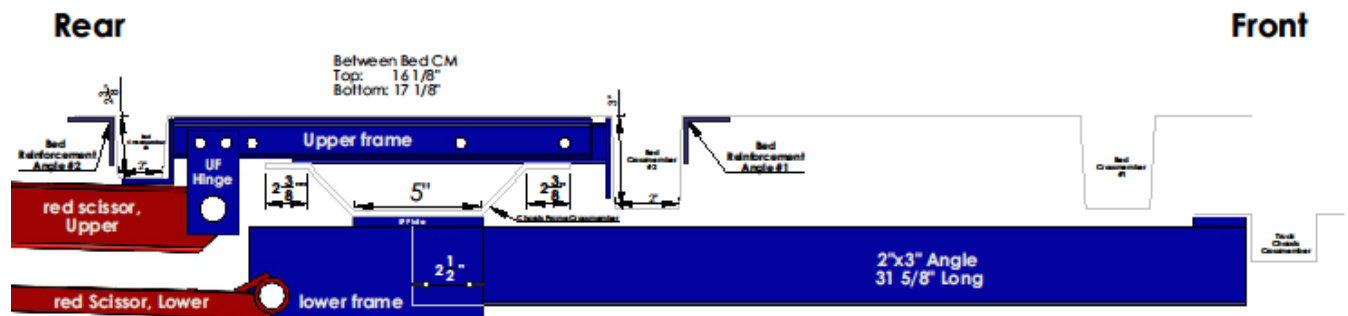

**Red Scissor**  
DETAIL A  
SCALE 1 : 4

## UPPER FRAME:

Assemble the upper frame using the shorter orientation for long bed trucks. Use the longer orientation for short bed trucks. Bolt the two halves together with (4) 3/8"-16 x 2.5" bolts. After assembling and bolting, weld the two pieces together for a stronger frame. Bolt the upper frame hinge to the upper frame using (4) 3/8"-16 x 1.5" bolts. On long beds, place the upper frame between cross member 2 and 3. On short bed's it will be placed between cross member 1 and 2. The flat end of the upper frame will be on the cab side, and the angle side of the upper frame will be on the rear side. The upper frame must be located fully as high as possible or it will interfere with the frame when the bed is down. Securely clamp the upper frame in place, keeping in mind that the upper frame will be offset to match the location of the lower frame. Lower the bed. If all is clear, including the gas tank, differential and brake lines, mark the location of the upper frame and the bolt holes for drilling. Note that moving the upper frame hinge allows adjustment of the scissor assembly with respect to the rear end. Remove the pin from the top section of the scissor assembly attaching it to the upper frame hinge. Now place the blue 42" support angles on the bed cross members where the upper frame is located. The upper frame will be bolted through the bed cross member, to the support angle. Clamp in place. Now drill holes through the bed cross member and support angle and bolt securely in place. The bed cross members cannot be crushed when sandwiched between these back up plates and the upper frame. They also add reinforcing to your bed. Reattach the scissor assembly to the upper frame and carefully move the bed up and down to check for proper operation and clearance.

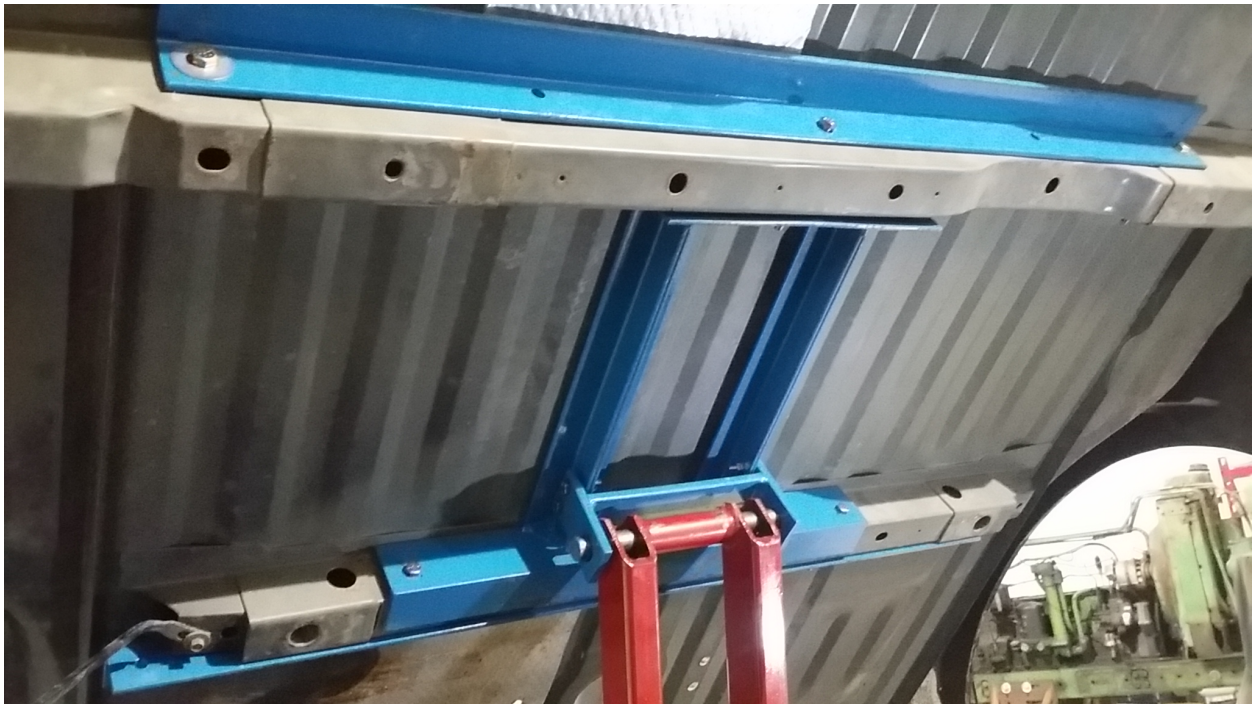

## **RUBBER BUMPER PADS:**

The bed should contact these for a quieter operation. Clean off the desired location on the truck or bed frame, near the front of the bed. Remove the adhesive back and attach the rubber bumper pads.

## **FUEL FILLER:**

For short bed trucks, move the inner fender brace to the front bed cross member. Remove the filler with the vent assembly. Cut off about 8" of inner portion of fuel filler and vent tubes. Reinsert using a small amount of lubricant (dish soap works best) back into the rubber hose. Rotate the filler so it reaches into the wheel well without interfering with wheel travel. Secure the filler bracket to the frame.

For long bed trucks, extend the gas filler from the front of the bed to the rear wheel well. Remove the filler assembly from the bed and inlet hose to the tank. Cut off 5" of rubber hose. Insert the short leg of the 9" x 22" filler pipe into what is remaining of the rubber filler hose to the tank. Aim the long leg of the elbow toward the rear wheel well. You will find that a bed cross member interferes with positioning the elbow high enough in the wheel well. Cut a notch in the cross member from the long seam outward (about 4"). Leave the top 1" of the cross member in place. Use the 5" piece of rubber to connect the elbow to the filler assembly. The filler opening should be forward of the wheel and as high as possible for good flow. The tire should not contact the filler assembly even when fully loaded to the suspension stops. The filler assembly will be secured in place with the blue Z-bracket. The 7" long side attaches to the frame in the wheel well. The filler assembly attaches to the 5" side with a large hose clamp.

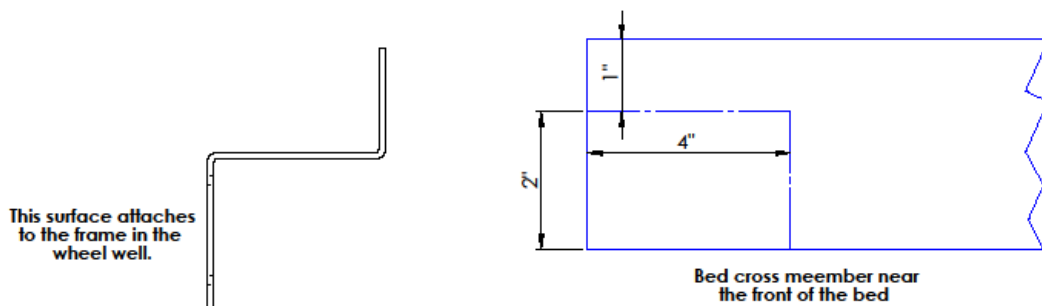

## **SUPPORT CABLE:**

There is some slack in the scissor assembly when installed. The provided cable installs under the scissors, attaching to both driver side and passenger side main frame. This supports the weight of the scissors and unloads the hinge pins. This will also help to keep the scissor assembly from hitting the rear differential.

## **PUMP:**

It is recommended that the pump mount to the outside of the right frame, just forward of the rear spring hanger (This is only recommended, not required. The pump can mount to any "safe" location) using the 8" x 7" L-bracket. The pump should be mounted level, with the vent/filler up, using (2) 3/8"-16 x 1" screws.

You may have to remove the magnetic coil in order to attach the adapter fitting to the pump body. Install the pump fitting and attach the hydraulic hose. Attach the opposite end of the hydraulic hose to the base end of the hydraulic cylinder.

On power down kits, the pump will have (2) ports. The port marked C1 is the high-pressure port. The port marked C2 is the low pressure (return) port. If the pump ports are not labelled, the port on the left-hand side (with the motor pointing towards you, and the reservoir pointing away from you) is the high-pressure port, and the port on the right side is the low-pressure (return) port

The pump's reservoir is supplied with a temporary plastic plug in the fill opening. Fill with up to 1.5 gallons of automatic transmission fluid (Actual amount will vary by pump supplied). After filling the reservoir, install the vented plastic plug into the fill opening. The vented plug is packed in the pump box.

Note\* Some pumps interfere with the vertical frame when the pump bracket is bolted to the frame. A 2" x 2" x 4" spacer is provided to space the pump bracket out from the frame for clearance. It generally will not be used.

## **GUIDES:**

The guides are the 2 parallelogram shaped pieces that attach to the bed and provide alignment of the bed to the truck, side to side. They attach to the front of the bed and contact the frame, either inside or outside. They also prevent any side to side movement when the bed is down. The bottom of the guides are pointed, so be sure that they do not contact anything other than the edge of the left and right frames.

## **WIRING:**

Wired pendant control:

The power wire (green) on the pendant control will connect to the large power terminal on the solenoid. The “start” wire (black) will connect to the small terminal on the solenoid. The “down” wire (white) will connect to the small terminal on the magnetic coil on the C1 port.

On power down pumps, the “up” wire (red) will connect to the magnetic coil on the C2 port.

\*To install a wireless remote, refer to the manufacturer’s installation instructions.

Optional In-Cab Toggle Switch Wiring:

Mount the switch in the dash, or somewhere convenient from the driver’s seat. The switch will mount in a ½” hole. Orient the switch so it moves up and down, vertically. Using the 18/3 ribbon wire, connect the brown wire to the center terminal on your toggle switch. The yellow wire will mount to the top terminal, and the green wire will connect to the bottom terminal.

Positive:

Mount the circuit breaker as close as possible to the battery. Cut the #4 gauge red wire so there is enough cable to reach from the battery’s positive terminal to the circuit breaker with a little slack. Connect the short cable to the positive terminal and the circuit breaker terminal marked “BAT LINE”. Using the remainder of the red wire, connect from the circuit breaker terminal marked “AUX LOAD” to the large terminal on the pump solenoid. Be sure that the red wire does not rub on anything that has a sharp edge, generates heat, or has moving parts.

Negative:

Connect the #4 gauge black wire to the mounting bolt on the side of the pump labelled “GND”. Route the black wire back to the battery. Connect the black wire directly to the negative terminal of the battery. The ground wire MUST be attached as described to the pump and to the battery. Do NOT cut the black wire short and ground to the frame.

NOTE\* Be sure not to connect any wire to the solenoid terminal that has a large copper buss bar connecting to the single pump motor terminal. Do not allow any wiring to touch the buss bar, or it’s connections. It is NOT a ground, it is the final connection to the motor.

## BUCHER PUMP to BREAKER

PM319 Bucher Pump

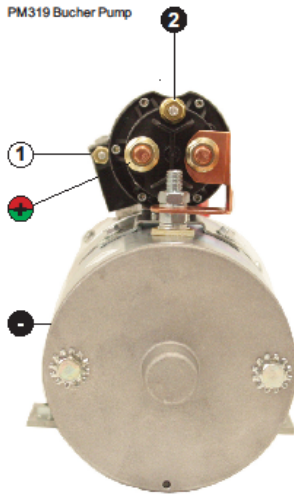

76631 Breaker

To protect your pump, please use a safety cutoff switch or ampere breaker.



### REMOTE CONNECTIONS

Pierce wired or wireless remotes including the P040 and CP271 connect to a PM319. Wired remotes will have three wires whereas the wireless connections will have four.

- ② UP (Black)
- ① DOWN (White)
- ⊕ POSITIVE (Red #4 Cable and Green)
- ⊖ NEGATIVE (Black #4 Cable)

## PIERCE

PierceArrow Inc. • www.piercearrowinc.com • 1-800-658-6301  
549 U.S. HWY 287 S. • Henrietta, Texas 76365

CATEGORY PUMP

PART NO. PM319

### PRODUCT DESCRIPTION

Bucher Pump to Breaker & Remote

### WIRING DESCRIPTION

This chart depicts wiring from a Bucher PM319 pump to the Pierce breaker.

NOTE: Place breaker as close to battery as install allows. Use #4 gauge cable for all connections. Use a 5/16-18" x 3/4" bolt for the ground connection. Wiring not included.

### WIRING CHART

Connect the wires to the corresponding signs.

- ⊕ POSITIVE (Red #4 Cable and Green)
- ⊖ NEGATIVE (Black #4 Cable)
- ① DOWN (White)
- ② UP (Black)

## BUCHER PUMP

Pm319 Bucher Pump to PS525 Toggle Switch

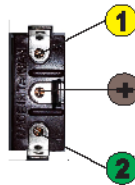
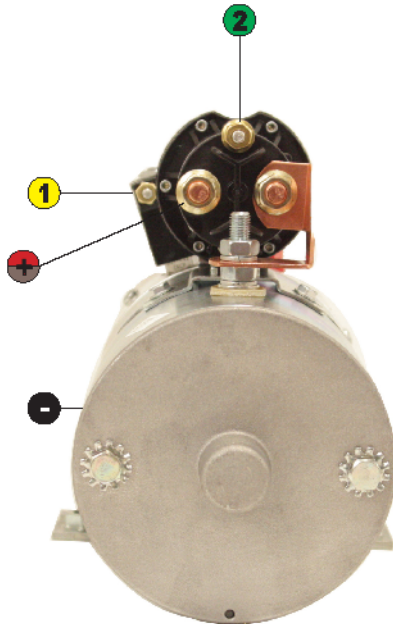

## PIERCE

PierceArrow Inc. • www.piercearrowinc.com • 1-800-658-6301  
549 U.S. HWY 287 S. • Henrietta, Texas 76365

CATEGORY PUMP

PART NO. Pm319, PM3196P

### PRODUCT DESCRIPTION

Bucher Pump to Toggle Switch

### WIRING DESCRIPTION

This chart depicts wiring from a Bucher PM319 pump to the Pierce PS525 Toggle Switch.

NOTE: Place breaker as close to battery as install allows. Use #4 gauge cable for all connections. Use a 5/16-18" x 3/4" bolt for the ground connection. Wiring not included.

### WIRING CHART

Connect the wires to the corresponding signs.

- ⊕ POSITIVE (red #4 Cable and Brown)
- ⊖ NEGATIVE (Black #4 Cable)
- ① DOWN (Yellow)
- ② UP (Green)

## BUCHER PUMP

PM319 Bucher Pump

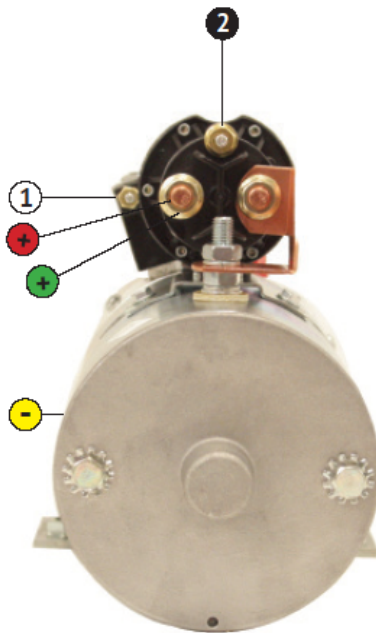

## PIERCE

Pierce Arrow Inc. • www.piercearrowinc.com • 1-800-658-6501  
549 U.S. HWY 287 S. • Henrietta, Texas 76565

CATEGORY PUMP

PART NO. PM319

PRODUCT DESCRIPTION  
Bucher Pump

WIRING DESCRIPTION  
This chart depicts wiring from a Bucher PM319 pump to the Pierce CP271MTE.  
NOTE: Place breaker as close to battery as install allows. Use #4 gauge cable for all connections. Use a 5/16-18" x 3/4" bolt for the ground connection. Wiring not included.

WIRING CHART  
Connect the wires to the corresponding signs.  

- + POSITIVE (red to the remote)
- + POSITIVE (green to main power)
- NEGATIVE (yellow to the main ground)
- 1 DOWN (white to the remote)
- 2 UP (black to the remote)

## BUCHER PUMP with TWO-WAY VALVE

PM-3551 Bucher Pump with CP077K wired control

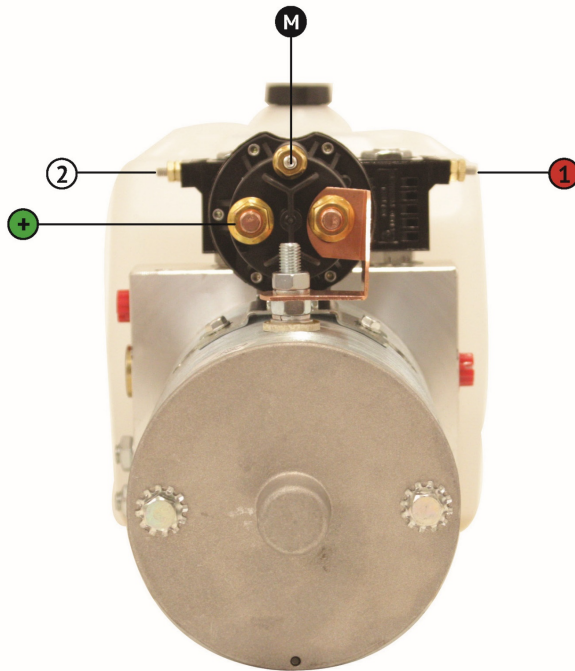

## PIERCE®

Pierce Arrow Inc. • www.piercearrowinc.com • 1-940-538-5643  
549 U.S. HWY 287 S. • Henrietta, Texas 76565

CATEGORY PUMP

PART NO. PM-3551

PRODUCT DESCRIPTION  
Bucher Pump with Two-way Valve

WIRING DESCRIPTION  
This chart depicts wiring of a Bucher PM-3551 pump.  
NOTE: Use #16 or #18 gauge wires for all connections. Use a 5/16-18" x 1/2" bolt for the ground connection. Wiring not included.

WIRING CHART  
Connect the wires to the corresponding signs.  

- + 12V (green)
- 1 RIGHT COIL (red)
- 2 LEFT COIL (white)
- M MASTER (black)  
Compatible with CPO77K, 38901155



## **REAR BUMPER:**

The rear bumper is only decorative and provides no function when the hoist kit is installed. Trailers should NOT be towed by the bumper. If there is no receiver hitch, the bumper brackets should be welded to the hinge arms so the bumper will rotate with the bed. The warning label provided with the kit should be applied to the bumper where it is clear and visible.

## **TOWING:**

Receiver hitches should clear the bed when raised, but may be required to be installed forward towards the cab, and usually down 2"-3". When your bed is in the fully raised position, you can determine exactly where the receiver will go. The receiver hitch installation and use MUST result in a unit that is as strong as in its original configuration. A longer ball mount must be purchased or fabricated from a 2" x 2" flat bar. Check for clearance; This way the bed cannot be inadvertently raised and damaged by the ball mount.

Alternate options:

- Fabricate a 2" high by 4" front to back rectangular tube bumper. It will mount just above the factory mounted receiver hitch and weld to the frame of the truck. The empty bumper pocket will fold over the top of your 2" x 4" bumper. This bumper will provide much more protection from collision than your original bumper. A piece of tread plate can be fitted to the bumper pocket so the bumper pocket is filled visually from the rear.
- Leave receiver hitch in the original location. Fill in the bumper pocket with appropriately sized tread plate. This will not provide protection, but will be more aesthetically pleasing than leaving the bed with no bumper covering.

## **MAINTENANCE:**

- Grease all pins, scissor assembly and hinges monthly.
- Fluid should be changed yearly. Once the reservoir is drained, remove the reservoir. Using a mild solvent, clean the screen filter on the suction tube. While the reservoir is off, clean out any debris. Re-install the reservoir, making sure to lubricate the sealing o-ring with hydraulic oil before seating to assist in re-installation. Tighten all screws/hose clamps.

- Check wiring, all connections, terminals and battery yearly. Corrosion will cause voltage drops. When corrosion is found, remove any corroded wire and replace any terminals when necessary. If any wire is found frayed or cut, it must be replaced.

## **TROUBLESHOOTING:**

- Bed will not lift:
  - First, check your voltage at the pump. Make sure that there is 12V at the solenoid terminal. Operate the pump and check the voltage again. Power should stay near 12V, but should not drop below 12V. If this is not achieved, check all wiring and all connections.
  - On Power down pumps, make sure that the pump is plumbed properly. The PM-3551 pump has two hydraulic ports. The port labelled C1 should be plumbed to the base end of the cylinder. The port labelled C2 should be plumbed to the rod end of the cylinder.
- Pump is slow
  - First, check your voltage at the pump. Make sure that there is 12V at the solenoid terminal. Operate the pump and check the voltage again. Power should stay near 12V, but should not drop below 12V. If this is not achieved, check all wiring and all connections.
  - Check suction tube filter for blockage (refer to maintenance).
- Leaks
  - Upon installation, there may be a bit of fluid seeping from the cylinder vent. This is not a leak, but merely residual fluid from pressure testing the cylinder.
  - If fluid is leaking from any fittings or hose, simply tighten the fitting. DO NOT use pipe thread sealant tape on any fittings. Only use pipe thread sealant paste. Tape can break loose and cause blockages in the hydraulic system.
- Call Pierce
  - In the event you need any assistance please call 800-658-6301.

## **Official Pierce Arrow Inc. Product Limited Warranty**

Pierce Arrow Inc. warrants that the goods, equipment, and merchandise manufactured by Pierce Arrow Inc. are free from defects in material and workmanship. The limited warranty includes replacement or repair of defective mechanical and electrical parts for a period of two years from the date of shipment by Pierce Arrow Inc.

### **OBTAINING PIERCE WARRANTY SERVICE**

Pierce Arrow Inc. must be notified of any defect before repair or replacement may be granted. The merchandise must be delivered by the purchaser to Pierce Arrow Inc. in Henrietta, Texas at the purchaser's expense. Any repairs not made by Pierce Arrow Inc. are not covered by the limited warranty and are the responsibility of the purchaser. Pierce Arrow Inc. reserves the right to repair or replace defective parts or products in its sole discretion. The cost of any repairs not covered by the warranty will be charged to the purchaser.

### **EXCLUSIONS**

All Pierce products are manufactured for a specific intended purpose. The Pierce Arrow Inc. limited warranty does not cover, and Pierce Arrow Inc. is not liable for, damage arising from any use other than the specific intended use of each product.

The Pierce Arrow Inc. limited warranty does not cover: Ongoing maintenance parts or repair due to normal wear and tear, and any change or defect due to accident, misuse or any use for which the equipment was not intended, improper or unauthorized repair, failure to provide regular maintenance, and deterioration due to weather or road conditions. Purchasers should consult their owner's manual for safety, installation, operation, and maintenance guidelines.

The Pierce Arrow Inc. limited warranty does not cover purchaser's cost of labor, transportation, shipping damages, installation or removal costs, down time, loss of profit or goodwill, or any other special, incidental, indirect, or consequential damages, concerning or related to any product or part, whether based upon negligence, strict liability, breach of contract, breach of warranty, misrepresentation, or any other legal theory. Merchandise manufactured by Pierce Arrow Inc. is not designed or intended for the movement of people and are not to be used in the operation of elevators or other improper uses. Any improper use of the product may void the warranty.

### **OTHER MANUFACTURERS' WARRANTIES**

Pierce Arrow Inc. makes no warranty, expressed or implied, to finished products manufactured or supplied by other manufacturers, and sold by Pierce Arrow Inc. to the purchaser, including but not limited to, any vehicle to which our products is affixed and any accessories. Such merchandise is subject to the manufacturer's warranty only, which will be provided upon request.

### **CONDITIONS OF SALE**

When placing an order with Pierce Arrow Inc., the terms and conditions provided for payment, shipping, delivery and claims create an agreement between the purchaser and Pierce Arrow Inc. The agreement is to be performed in Clay County, Texas.

### **RETURNS**

No returns are accepted without prior authorization. All items must be returned in their entirety. Please contact a sales representative for authorization. Upon authorization, returns must be shipped freight prepaid and may be subject to a 15% restocking fee. Please do not send returns COD. No returns will be accepted later than 30 days from the date of invoice.

### **DAMAGED GOODS**

Pierce Arrow Inc. is not responsible for, and has no liability for:

Damage arising during shipment, damage arising during purchaser's assembly, installation, or construction of or with the products, and damage arising from accident, misuse or any use for which the equipment was not intended, improper or unauthorized repair, or weather or road conditions.

### **CLAIMS**

Claims for breakage or damages during shipment must be made to the carrier at the time of delivery. If a signature is required, you must notify the driver and sign that there was damage. You must notify Pierce Arrow Inc. of the damage promptly so that a claim can be filed.